



CORTEX[®]

CATALOGUE 2020



CARDIO ■ STRENGTH ■ THERAPY ■ ACCESSORIES



BROWSE OUR RANGE

CARDIO

TREADMILLS	3
TREADMILL DESK & WORKSTATIONS	9
UPRIGHT EXERCISE BIKES	10
ROWING MACHINES	11
WATER RESISTANCE ROWING MACHINES	12
SPIN BIKES	14
RECUMBENT BIKES	17
ELLIPTICAL CROSS TRAINERS	17
EQUIPMENT ACCESSORIES	19

STRENGTH

EXERCISE BENCHES	20
POWER RACKS & TOWERS	21
LEG PRESS & INVERSION TABLE	22
GYM STATIONS	23

WEIGHTS

DUMBBELLS	25
KETTLEBELLS	26
WEIGHTED VESTS	27
OLYMPIC BARS & WEIGHTS	28
WEIGHT TRAINING ACCESSORIES	31
STANDARD BARDS & WEIGHTS	32
WEIGHT BALLS & BAGS	34

FUNCTIONAL TRAINING

PLYOMETRIC BOXES	35
------------------	----

REHABILITATION

ACCESSORIES	36
YOGA & THERAPY	37
RESISTANCE BANDS	39

ARC TREADMILL

TMARC

- 1.0 CHP Heavy Duty H1 Motor
- DuraGrip® AS belt 1000mm x 360mm (L x W)
- Light and compact



1.0 TO 10 KM/H SPEED



FOLDABLE FOR EASY STORAGE



EKG HAND PULSE SENSORS



REFORMER TREADMILL

TMREFORMER

- 2.25 CHP EverDrive® H3 Motor
- DuraGrip® AS belt 1200mm x 400mm (L x W)
- ShockControl™ Advanced Cushioning System
- Hand rails for safety



12 LEVELS AUTO INCLINE



0.3 TO 14 KM/H SPEED



EKG HAND PULSE SENSORS



TORQUE 3 TREADMILL

TMTORQUE3

- 4.0 CHP EverDrive® H6 Motor
- DuraGrip® AS belt 1300mm x 540mm (L x W)
- ShockControl™ Advanced Cushioning System



20 LEVELS AUTO INCLINE



1.0 TO 18 KM/H SPEED



EKG HAND PULSE SENSORS



TREADMILL SAFETY KEY

TMSAFETYKEY-GENERIC

- 30mm diameter key
- Total length 1.0m

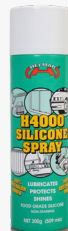

SILICONE SPRAY

SILSPRAY

Lubricate your treadmill running deck with our recommended multi-purpose silicone spray.

- 300g NET / 509ml



TREADMILL MAT 2.0M

MATTREADMILL

- Protects your equipment and floor
- 200cm x 100cm (L x W)
- 4mm thick

CORSAIR FREERUN 200 CURVED TREADMILL

TMCORSAIRFR200

- Magnetic free-run system
- Self-generator powers display
- Running deck 1600mm x 480mm (L x W)
- 13mm belt thickness



12 LEVELS OF MANUAL RESISTANCE



UNLIMITED SPEED



LCD DISPLAY



ECO-FRIENDLY MOTOR-LESS SYSTEM



CORSAIR FREERUN 100 CURVED TREADMILL

TMCORSAIRFR100

- Commercial grade running slat belt 1700mm x 440mm (L x W)
- Curved running belt design
- High Intensity Interval Training (HIIT)



UNLIMITED SPEED



REDUCE CARBON FOOTPRINT



LCD DISPLAY



FitLink Compatible

Sync, record and manage your workout data on your phone.*

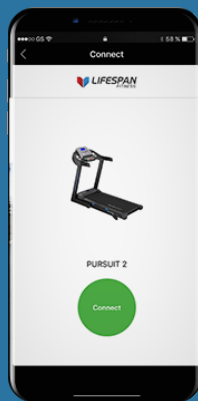

SYNC TO YOUR EQUIPMENT

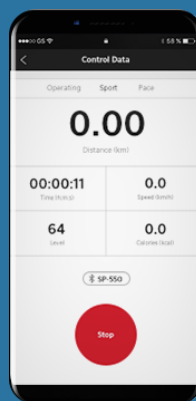

TRACK & RECORD PROGRESS

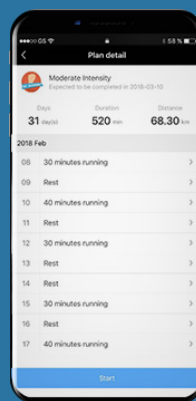

COMPLETE TRAINING PROGRAMS

*Compatible with Android or iOS devices

PURSUIT TREADMILL

TM PURSUIT 2

- 2.0 CHP EverDrive® H2 Motor
- DuraGrip® AS belt 1200mm x 430mm (L x W)
- ShockControl™ Basic Cushioning System

3 LEVELS
MANUAL INCLINE

0.8 TO 14 KM/H
SPEED

LARGE BACKLIT
LCD DISPLAY

FitLink



BOOST-R TREADMILL

TM BOOST-R

- 2.75 CHP EverDrive® H5 Motor
- DuraGrip® AS belt 1300mm x 450mm (L x W)
- ShockControl™ Advanced Cushioning System

18 LEVELS
AUTO INCLINE

1.0 TO 18 KM/H
SPEED

FULL COLOUR
7" LCD DISPLAY

VIDEO AND MUSIC
PLAYBACK

FitLink



APEX TREADMILL

TM APEX

- 3.25 CHP EverDrive® H6 Motor
- DuraGrip® AS belt 1400mm x 510mm (L x W)
- ShockControl™ Advanced Cushioning System

18 LEVELS
AUTO INCLINE

1.0 TO 18 KM/H
SPEED

FULL COLOUR
7" LCD DISPLAY

VIDEO AND MUSIC
PLAYBACK

FitLink



VIPER TREADMILL

TMVIPERM3

- 3.75 CHP EverDrive® H7 Motor
- Adv. running deck (1500mm x 520mm)
- Bonus POLAR heart rate chest strap
- ShockControl™ Advanced Cushioning



22 LEVELS AUTO INCLINE



1.0 TO 20 KM/H SPEED



EKG HAND PULSE SENSORS

Experience the cutting edge of running tech with the high-performance Viper. This luxe fitness machine with serious training capabilities features the 3.75 CHP EverDrive® H7 Motor and spacious DuraGrip® Ultra commercial belt to suit any stride length or foot size.



Assembled size: 195cm x 88cm x 150cm (L x W x H)

POLAR
HEART RATE CONTROL



FitLink

SHOCKCONTROL™
ADVANCED CUSHIONING

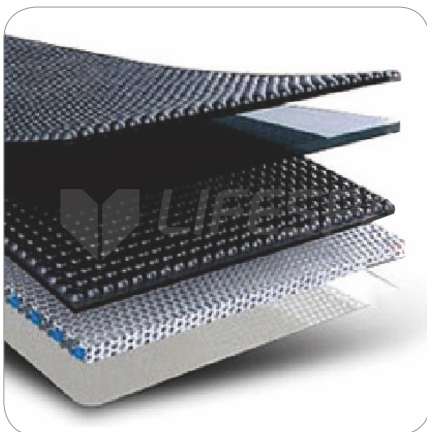

COMMERCIAL GRADE RUNNING BELT

Commercial grade running belt that is designed to last longer than your standard treadmill belt. Five layers to provide superior grip, noise reduction and essential shock absorption during use.



IMPACT CUSHIONING SYSTEM

The ShockControl™ System provides a balance of cushioning and stability for a better quality workout. Protect your knees and joints during workouts with a combination of suspension points, impact absorbing running board and PentaLayer™ treadmill belt.



SAVE SPACE WITH HYDRAASSIST®

HydraAssist® creates a simple and effortless way to fold up your treadmill, and a soft-drop mechanism when unfolding your treadmill. Once folded, our Treadmill features transportation wheels for easy mobility.

EVEREST TREADMILL



22% INCLINE

0% INCLINE
6% DECLINE

Ultimate Calorie Burner

Up to a true 22% incline and 6% decline

Get the ultimate calorie burn and intensify your workout by cranking up the automatic incline to a whopping 22% true incline (Level 20) at the push of a button. It doesn't take long until you'll feel the burn on the Everest. Simulate down-hill environments and target a different muscle group with a 6% decline.



TMEVEREST

- 4.0 CHP EverDrive® H8 Motor
- DuraGrip® Ultra belt 1550mm x 510mm (L x W)
- Ultra Thick Pentalayer™ 5-layer commercial belt
- ShockControl™ Advanced Cushioning

Assembled size: 178cm x 91cm x 179.5cm (L x W x H)

 22 22% MAX. INCLINE

 -6 6% MAX. DECLINE

 1.0 TO 24 KM/H SPEED

MARATHON COMMERCIAL TREADMILL



Assembled size: 196cm x 88cm x 156cm (L x W x H)

TMMARATHON

- 4.0 CHP AC EverDrive® H7 AC Motor
- DuraGrip® Ultra belt 1520mm x 560mm (L x W)
- PentaLayer™ 5-layer commercial belt
- Interactive display with workout programs
- Screen cast function with Android/iOS
- WiFi connectivity



20 LEVELS AUTO INCLINE



0.3 TO 20 KM/H SPEED



FULL COLOUR 15.6 LCD DISPLAY

The ultimate treadmill, the Marathon delivers a top of the range running experience with its robust commercial components coupled with an intelligent display system on an impressive 15.6" LCD display. Cutting edge technology allows you to play videos and music to keep you entertained during your training sessions. You can even case content from your smart device to help guide you or for futher entertainment.

POLAR
HEART RATE CONTROL

EverDrive
MOTOR

SHOCKCONTROL
ADVANCED CUSHIONING

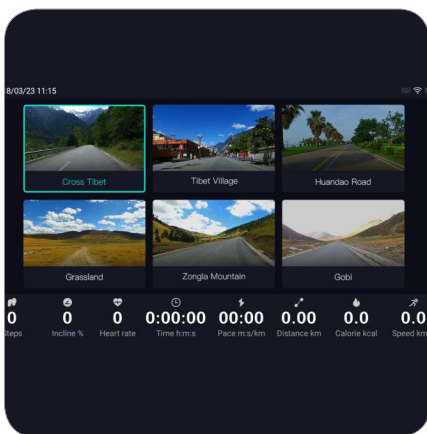

TAKE TO THE OPEN ROAD

Exercise indoors and see the world. Simulate any of Marathon's pre-set environments to give you the real outdoor running feel.



IN-RUN ENTERTAINMENT

Experience the full colour 15.6" LCD display of the Marathon and play/cast any of your favourite videos and music.



MEDIA STREAMING

With Marathon's screen cast function, stream your favourite entertainment or work-out video at a push of a button.

*Please check with us for compatibility

01 WALKSTATION B TREADMILL

TMWALKSTATIONB

Our Walkstation B offers a flexible and versatile treadmill base and console unit to fit under your standing desk.

- 2.25 CHP EverDrive® H6 Motor
- DuraGrip® AS belt
1400mm x 510mm (L x W)
- Wired desktop controller
- ShockControl™ Basic Cushioning



0.8 TO 8 KM/H
SPEED RANGE



REMOTE CONTROL
INCLUDED

02 ERGO STANDING DESK

ERGODESK

Our Ergo Standing Desk is designed as a versatile work station to be used in all types of office or home applications.

- Table cord grommet
- 110cm x 60.5cm (L x W) desktop
- Table load capacity of 80kg



100CM TO 135CM
ADJUSTABLE HEIGHT RANGE



WALKSTATION L1 TREADMILL

TMWALKSTATIONL1

- 2.25 CHP EverDrive® H3X Brushless Motor
- DuraGrip® AS belt
1200mm x 450mm (L x W)
- Wired desktop controller
- ShockControl™ Basic Cushioning



0.8 TO 8 KM/H
SPEED RANGE



REMOTE CONTROL
INCLUDED



CYCLESTATION

CYCLESTATION

Our portable and versatile cyclestation allows you to exercise anywhere.

- Extendable LCD monitor to show stats
- Fits under desks



2.5KG HEAVY DUTY
MAGNETIC FLYWHEEL



8 LEVELS OF
RESISTANCE



COMPACT



EXER-11 FOLDING EXERCISE BIKE

EXER11

- Variable manual resistance, 8 levels
- 3-piece forged steel crank
- Adjustable seat height



EASY FOLD-UP DESIGN



MAGNETIC HEAVY DUTY CAST IRON FLYWHEEL



8 LEVELS ADJUSTMENT SYSTEM



EXER-60H DUAL ACTION EXERCISE BIKE

EXER60H

- Variable manual resistance, 8 levels
- Dual action works both arms and legs
- Saddle vertically and horizontally adjustable



HEAVY DUTY MAGNETIC FLYWHEEL



8 LEVELS OF MANUAL RESISTANCE



PULSE SENSORS



EXER-58 EXERCISE BIKE

EXER58

- Variable manual resistance, 8 levels
- 3-piece crank
- Saddle vertically and horizontally adjustable



HEAVY DUTY MAGNETIC FLYWHEEL



8 LEVELS OF MANUAL RESISTANCE



SMOOTH AND SILENT BELT TRANSMISSION



EXER-80 EXERCISE BIKE

EXER80

- Variable automatic resistance, 16 levels
- Smooth belt drive system
- 3-piece crank
- Four way saddle adjustment
- 16 workout programs



6KG HEAVY DUTY MAGNETIC FLYWHEEL



16 LEVELS COMPUTERISED MAGNETIC TENSION



PULSE SENSORS



EXER-90H EXERCISE AIR BIKE

EXER90H

- Dynamic air resistance for ultimate workout
- Dual action works both arms and legs
- 4-way saddle adjustment
- Dynamic rotating crank - forged steel
- Extra wide seat for comfort



AIR RESISTANCE SYSTEM



25" DIAMETER STEEL FRAME



EXPONENTIAL RESISTANCE



ROWER-605 MAGNETIC ROWING MACHINE

ROWER605

- Variable automatic resistance, 16 levels
- 39Kg/F max resistance tested
- Quiet drivetrain
- Commercial quality rollers
- Multi-functional LCD display
- Contoured comfortable seat
- 19 workout programs
- Includes POLAR T34 Wireless HR Transmitter



HEAVY DUTY CAST IRON FLYWHEEL



16 LEVEL MAGNETIC RESISTANCE



FOLDABLE FOR EASY STORAGE



HEART RATE CONTROL



ROWER-445 MAGNETIC ROWING MACHINE

ROWER445

- Variable manual resistance, 16 levels
- 18Kg/F max resistance tested
- Quiet drivetrain
- Commercial quality rollers
- Multi-functional LCD display
- Contoured comfortable seat



HEAVY DUTY CAST IRON FLYWHEEL



16 LEVEL MAGNETIC TENSION CONTROL



FOLDABLE FOR EASY STORAGE



WATER RESISTANCE ROWING MACHINES



SMOOTH ROWING ACTION

The water resistance rower's water chamber allows for exceptionally smooth and consistent rowing. The system allows for zero delay in resistance, you'll feel a smooth and consistent row right from the first stroke. No jerking or jarring to ruin your rhythm or make your workout unpleasant.

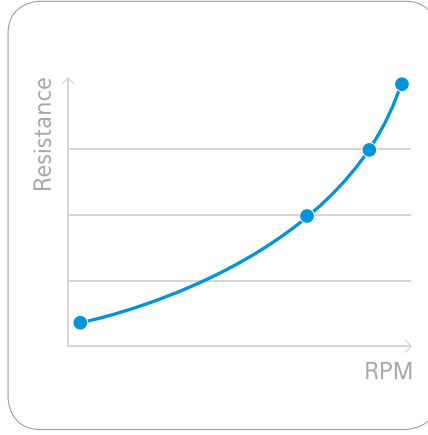

EXPONENTIAL RESISTANCE CURVE

Similar to on-water rowing, the resistance is determined by the amount of effort placed in each row. Row harder and you'll go faster, row easier and you'll go slower. Exponential and dynamic resistance to suit any fitness level.



REALISTIC ROWING FEEL

In order to replicate the feel of a rowing scull pushing through water, our water resistance rower comes with a water filled chamber coupled with an impeller that spins and pushes water around. This system offers the closest experience and feel to on-water rowing for an excellent workout or training session.

ROWER-700 WATER RESISTANCE ROWING MACHINE

ROWER700

- Belt drivetrain
- Multi-functional LCD display
- Store in an upright position



WATER RESISTANCE SYSTEM



REALISTIC ROWING FEEL



DYNAMIC RESISTANCE



ROWER-750 WATER RESISTANCE ROWING MACHINE

ROWER700

- Timber look to fit any decor
- Belt drivetrain
- Multi-functional LCD display
- Store in an upright position
- Contoured rowing seat



DYNAMIC RESISTANCE



SMOOTH AND EXPONENTIAL RESISTANCE



TIMBER FRAME



ROWER-810 WATER RESISTANCE ROWING MACHINE

ROWER810

- Built to commercial standards
- Belt drivetrain
- Multi-functional LCD display
- Contoured rowing seat



WATER RESISTANCE SYSTEM



REALISTIC ROWING FEEL



DYNAMIC RESISTANCE



ROWER-800F AIR & MAGNETIC ROWING MACHINE

ROWER800F

- Air and magnetic hybrid resistance system
- Variable automatic resistance, 16 levels
- Multi-functional LCD display
- Built to commercial standards
- Heart rate chest strap compatible (sold separately)



HEAVY DUTY CAST IRON FLYWHEEL



16 LEVELS MAGNETIC RESISTANCE



WIRELESS HR COMPATIBLE



FitLink



SP-960 SPIN BIKE



4-Way Adjustable Handlebar

Wide Comfortable Premium Racing Seat

Unlimited Resistance

4-Way Adjustable Saddle

25kg Commercial Flywheel

Commercial Grade Cranks & Pedals

SP960

- Large 8" LCD display
- Wireless heart rate monitor compatible
- Commercial tubular steel frame
- Multi-functional LCD display

POLAR
HEART RATE CONTROL
(Strap sold separately)

 25KG TRUESPIN™ PRECISION FLYWHEEL

 UNLIMITED RESISTANCE

 HEAVY DUTY BELT DRIVETRAIN



ALLOY FRAME COMPONENTS

Designed to exceed commercial quality standards, the SP-960 features precision cut alloy frame components. These result in seamless seat and handlebar adjustments, that will also reduce rust in high moisture environments.



SILENDRIVE™ SYSTEM

Enjoy a smooth, quiet ride. Designed to be extra durable, the belt drive system requires less maintenance and is virtually noiseless: perfect for homes or gyms.



TRUESPIN™ PRECISION FLYWHEEL

All TrueSpin™ flywheels are precision balance tested against stringent standards. This allows for smoother rides, minimizes flywheel knocking noises and prolongs bearing and axle life.

SP-310 SPIN BIKE

SP310

- Aluminum alloy pedals with toe clips
- 4-way adjustable seat
- 130cm x 125cm (L x H) steel frame

-  13KG TRUESPIN™ HEAVY DUTY FLYWHEEL
-  UNLIMITED RESISTANCE
-  CHAIN DRIVETRAIN



SP-340 SPIN BIKE

SP340

- Aluminium alloy pedals with toe clips
- 4-way adjustable seat
- 117cm x 104cm (L x H) steel frame



-  13KG TRUESPIN™ HEAVY DUTY FLYWHEEL
-  UNLIMITED RESISTANCE
-  HEAVY DUTY BELT DRIVETRAIN



SP-460 SPIN BIKE

SP460

- Aluminium alloy pedals with toe clips
- 4-way adjustable seat
- 130cm x 125cm (L x H) steel frame

-  18KG TRUESPIN™ HEAVY DUTY FLYWHEEL
-  UNLIMITED RESISTANCE
-  CHAIN DRIVETRAIN



SP-550 SPIN BIKE

SP550

- Aluminium alloy pedals with toe clips
- 4-way adjustable seat
- 140cm x 118cm (L x H) steel frame

-  18KG TRUESPIN™ HEAVY DUTY FLYWHEEL
-  UNLIMITED RESISTANCE
-  HEAVY DUTY BELT DRIVETRAIN



SP-870 M2 SPIN BIKE

SP870M2

- Quiet belt drivetrain
- Commercial grade crank and pedals
- 4-way adjustable premium racing seat
- Commercial grade steel frame



25KG TRUESPIN™ HEAVY DUTY CARBON STEEL FLYWHEEL



UNLIMITED RESISTANCE



HEAVY DUTY BELT DRIVETRAIN







MAGNETIC RESISTANCE



Maintenance Free



Silent Resistance



Smooth Pedalling

SM-100 MAGNETIC SPIN BIKE

SM100

- Two way handlebar adjustment
- 3-piece forged steel crank
- Multi-functional LCD display



13KG HEAVY DUTY CAST IRON FLYWHEEL



8 LEVELS ADJUSTABLE MAGNETIC RESISTANCE



SMOOTH BELT DRIVETRAIN



SM-400 MAGNETIC SPIN BIKE

SM400

- Two way handlebar adjustment
- 3-piece forged steel crank
- Multi-functional LCD display



18KG HEAVY DUTY CAST IRON FLYWHEEL



MANUAL ADJUSTABLE MAGNETIC RESISTANCE



SMOOTH BELT DRIVETRAIN



VELO PLUSH SEAT

SEATVELO

- Comfortable alternative to a standard sport saddle.



EQUIPMENT MAT 1.5M

MATEXEREQUIP

- 150cm x 100cm (L x 1W)
- 4mm thick

RECUMBENT BIKES

RC-81 RECUMBENT BIKE

RC81

- Variable manual resistance, 10 levels
- Heavy duty magnetic flywheel
- Adjustable seat length
- Large LCD display



ERGONOMIC SEAT



IPAD/TABLET/
BOOK STAND



PULSE SENSORS



RC-300 RECUMBENT BIKE

RC300

- Variable automatic resistance, 16 levels
- Heavy duty magnetic flywheel
- 15 workout programs
- Adjustable seat length
- Large LCD display



ERGONOMIC SEAT



IPAD/TABLET/
BOOK STAND



PULSE SENSORS



ELLIPTICAL CROSS TRAINERS

X-02 HYBRID CROSS TRAINER

X02

- Hybrid exercise bike and cross trainer
- Chain drivetrain
- Easy to read LCD display
- Bonus dumbbells and resistance bands



28CM STRIDE LENGTH



MANUAL ADJUSTABLE
MECHANICAL RESISTANCE



EKG HAND PULSE SENSORS



REVERSIBLE MOTION



X-18 CROSS TRAINER

X18

- Variable manual resistance, 8 levels
- Heavy duty magnetic flywheel
- Silent belt drivetrain
- LCD computer display
- Fixed handlebar



33CM STRIDE LENGTH



REVERSIBLE MOTION



EKG HAND PULSE SENSORS

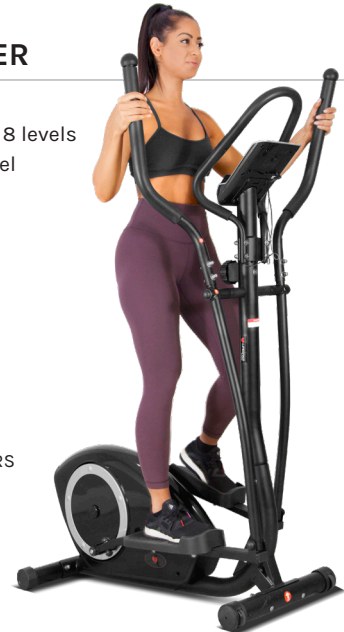

X-22 CROSS TRAINER

X22

- Variable automatic resistance, 16 levels
- 24 workout programs
- Silent belt drivetrain
- Built-in pulse sensors
- Large LCD display



36CM STRIDE LENGTH



16 LEVELS OF AUTO
RESISTANCE



EKG HAND PULSE SENSORS



REVERSIBLE MOTION



X-41 CROSS TRAINER

X41

- Variable automatic resistance, 16 levels
- 18 workout programs
- LCD computer display
- Built-in pulse sensors
- Music plug-in



46CM STRIDE LENGTH



16 LEVELS OF AUTO
RESISTANCE



EKG HAND PULSE SENSORS



REVERSIBLE MOTION





TABLET
HOLDER

ST-13 STEPPER WITH AUTO INCLINE

ST13

- Variable automatic resistance, 24 levels
- 15 levels automatic incline
- 12 workout programs
- 8kg heavy duty magnetic flywheel
- LED display dot matrix



HYBRID MAGNETIC AND
AIR RESISTANCE SYSTEM



15 LEVELS AUTO INCLINE



EKG HAND PULSE SENSORS

ST-14 VERTEX STAIR CLIMBER

ST14

- High intensity cardio burn
- Build strength and tone lower half
- Speed: 24spm - 164spm
- Large LCD display



15 LEVELS OF SPEED



200KG MAX WEIGHT



COMMERCIAL GRADE DESIGN



XT-38 CROSS TRAINER

XT38

- Variable automatic resistance, 16 levels
- Heavy duty cast iron magnetic flywheel
- Natural stride with front wheel elliptical
- Smooth rear-rollers
- Backlit large LCD screen



46CM STRIDE LENGTH



16 LEVELS OF AUTO
RESISTANCE



REVERSIBLE MOTION



EKG HAND PULSE
SENSORS



XT-44 CROSS TRAINER

XT44

- Variable automatic resistance, 24 levels
- 12 workout programs
- 8kg heavy duty magnetic flywheel
- LED display DOT matrix



DYNAMIC HYBRID AIR AND
MAGNETIC RESISTANCE



HUGE 52CM
STRIDE LENGTH



REVERSIBLE MOTION



EKG HAND
PULSE SENSORS



WIRELESS HEART RATE MONITOR

CHESTSTRAPG1

- Compatible with 5.3khz frequency devices
- Fasten securely
- Greater accuracy
- Comfortable design



POLAR T34 WIRELESS HEART RATE MONITOR

CHESTSTRAPPOLAR

- Compatible with 5.3khz frequency devices
- Fasten securely
- Greater accuracy
- Comfortable design



RUBBER GYM FLOOR MAT 15MM

MATGYM15

- Protects flooring and absorbs vibrations
- 100cm x 100cm (L x W)
- 860kg/m³ density

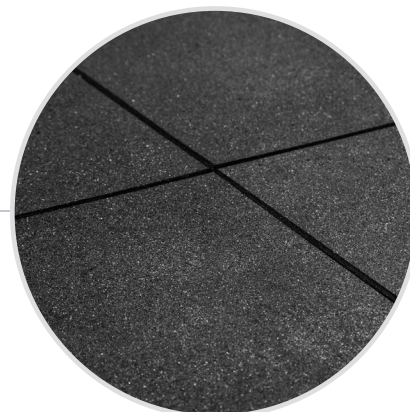

EQUIPMENT COVERS

Our covers are great for keeping dust and unwanted debris away from your fitness equipment.

- Made from reliable polyester fabric.
- Resistant to most chemicals, stretching and shrinking, wrinkle resistant, mildew and abrasion resistant





EQUIPMENT COVERS	MEASUREMENTS (L X W X H)
Universal S/M Treadmill Cover TMCOVER-S	100cm x 59cm x 146cm
Universal L/XL Treadmill Cover TMCOVER-L	120cm x 85cm x 160cm
Universal Exercise Bike Cover COVEREB	115cm x 57cm x 148cm
Universal Spin Bike Cover COVERSB	130cm x 52cm x 125cm
Universal Cross Trainer Cover COVERCT	172cm x 64cm x 145cm
Universal Recumbent Bike Cover COVERRB	170cm x 66.5cm x 110cm

HYPER EXTENSION ROMAN CHAIR

BENCHROMANCHAIR

- Sturdy steel frame
- Target hamstrings, abdominals, lower back muscles
- Comfortable thick padding

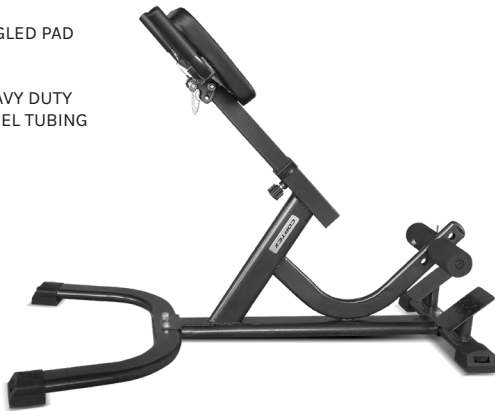

-  ANGLED PAD
-  HEAVY DUTY STEEL TUBING



AB10 SIT UP BENCH

BENCHAB10

- Target abs and trim waist
- Spring expander with row handle for rows, face-pulls or curls.
- High density padding



-  ADJUSTABLE INCLINE
-  HEAVY DUTY STEEL FRAME



BN-6 BENCH

BENCHBN6

- Fully adjustable bench with six levels (flat, incline, decline)
- Modular attachments for dip/chin ups
- High density padding

-  ADJUSTABLE SEAT HEIGHT (2 LEVELS)
-  HEAVY DUTY STEEL TUBING



BENCHBN6-SET

- Set includes chin up attachment and dip attachment



BENCHBN6CUP





BENCHBN6DIP

BN-2 ADJUSTABLE BENCH

BENCHBN2

- Comes with a pair of resistance band handles
- Adjustable thigh support
- Leg extension with 25mm weight holder

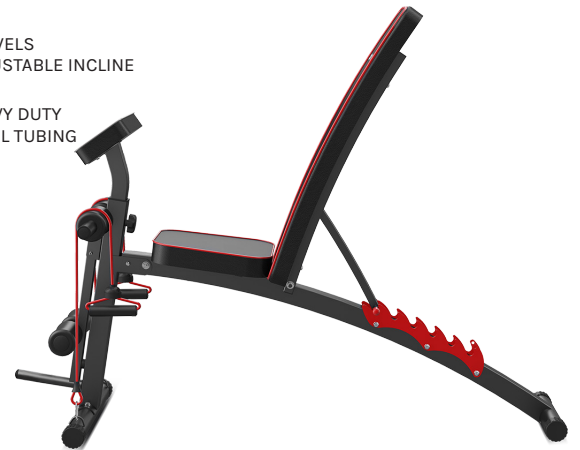

-  6 LEVELS ADJUSTABLE INCLINE
-  HEAVY DUTY STEEL TUBING



MF-4000 MULTI-FUNCTION BENCH PRESS

BENCHMF4000

- Extendable and reversible barbell holder
- Adjustable leg rollers
- High density padding



-  ADJUSTABLE ANGLE (FLAT / INCLINE)
-  BARBELL HOOKS
-  SAFETY SPOTS



MF-4000 + 120KG WEIGHT SET PACKAGE

BENCHMF4000+120KG

- Includes MF-4000 bench
- Includes 120kg standard
- Cast iron weight set

-  ADJUSTABLE ANGLE (FLAT / INCLINE)
-  BARBELL HOOKS
-  SAFETY SPOTS



PT-1 POWER TOWER

POWERTOWERPT1

Versatile 4-way power tower for a big range of exercises.

Great for:

- Dips
- Leg raises
- Vertical knee raises
- Chin ups/pull ups
- Push ups



4-WAY POWER TOWER



HEAVY DUTY STEEL TUBING



PTX-100 POWER TOWER

POWERTOWERPTX100

Great 2-in-1 tower with a 4-way power tower and in-built foldable flat or decline bench.

Great for:

- Dumbbell/barbell workouts
- Ab crunches/sit-ups
- Vertical knee raises
- Chin ups/pull ups
- Push ups



4-WAY POWER TOWER



HEAVY DUTY STEEL TUBING



SR-1 SQUAT RACK

SQUATRACKSR1

Our squat stands are great for barbell bench press, back & front squats, shoulder press and more.

- Adjustable stand width
- Can be used for dips



ADJUSTABLE BARBELL SAFETY BAR



HEAVY DUTY STEEL TUBING



ADJUSTABLE J HOOKS



SR-2 SQUAT RACK

SQUATRACKSR2

Solid, strong, and tall 1.8m squat rack. Perfect for squats, bench press, military shoulder press, and many more.

- 40cm safety spots
- Resistance band pegs



ADJUSTABLE BARBELL SAFETY BAR



HEAVY DUTY STEEL TUBING



ADJUSTABLE J HOOKS



*Weights and bar not included

PR-2 HALF RACK

POWERRACKPR2

Versatile half-rack designed for olympic and standard barbells.

- Wide grip pull up handles
- Resistance band pegs
- 4 x Weight storage sleeves
- 2 x Olympic barbell storage slots



ADJUSTABLE BARBELL SAFETY BAR



HEAVY DUTY STEEL TUBING



ADJUSTABLE J HOOKS



*Weights and bar not included

PT-150 POWER TOWER

POWERTOWERPT150

- 4-way stand
- Exercises ranging from chin ups, dips, leg raises and wide-grip exercises



COMMERCIAL GRADE DESIGN



HEAVY DUTY STEEL TUBING



PR-3 POWER RACK

POWERRACKPR3

Multipurpose full-rack, great for a huge variety of exercises like bench press and squats.

- Precision hole configuration
- 25mm hole spacing in bench press section
- 50mm hole spacing in squat/overhead press section



ADJUSTABLE BARBELL SAFETY BAR



HEAVY DUTY STEEL TUBING



ADJUSTABLE J HOOKS

*Weights and bar not included



LEG PRESS & INVERSION TABLE

LPI VERTICAL LEG PRESS

STATIONLPI

Compact leg press compatible with olympic and standard weight plates.

- Adjustable safety pins
- High density padding
- Back support



COMPATIBLE WITH STANDARD AND OLYMPIC



200KG MAX WEIGHT

*Weights not included



COMMERCIAL POWER SLED

POWERSLEDC1

- Push or pull workouts
- Low and high position handles
- Includes harness



COMPATIBLE WITH OLYMPIC WEIGHTS



HEAVY DUTY STEEL TUBING



QUANTUM 2 INVERSION TABLE

INVERSIONTABLEQUANTUM2

Take advantage of inversion therapy. De-compress spinal area to relieve back pain or prolonged back stress.

- Allows an inversion range of 180°
- Adjustable user height range from 130cm to 190cm
- Helps reduce back stress



LEVERLOCK® SYSTEM



125KG MAX WEIGHT



ADJUSTABLE LUMBAR SUPPORT



SS2 & GS6 GYM STATIONS

STATIONSS2 | STATIONGS6

- 78kg weight stack (expandable)
- Height adjustable seat and preacher pad
- Workout diagram chart provided
- 4 attachments included
- Free-standing and foldable ab bench (GS6 only)
- Integrated power tower (GS6 only)

PACKAGE	INCLUDES
GS6 Pro Gym Package STATIONGS6-PRO	GS6 Multistation MF-4000 Bench
GS6 Ultimate Gym Package STATIONGS6-ULTIMATE	GS6 Multistation MF-4000 Bench 103kg Upgraded Weight Stack

 CUSTOMISABLE WEIGHT STACK

 2000LB TENSILE STRENGTH CABLES











 38+ EXERCISES FOR A FULL BODY WORKOUT



Assembled size: 211cm x 163cm x 248cm (L x W x H)

*Additional 25kg weight stack can be purchased additionally, or included if purchasing GS6 Ultimate Gym Package.

GYM STATION ATTACHMENTS

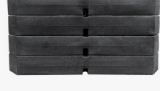
	Close Grip V Handle ATTACHVTRIANGLE		D Stirrup Handle ATTACHSTIRRUPHANDLE		Tricep Rope ATTACHTRICEPROPE
	D Bar ATTACHDBAR		Revolving Straight Bar ATTACHREVOLVESTRAIGHTBAR		Tri Pushdown Bar ATTACHTRIPRESSBAR
	Lat Pulldown Bar ATTACHLATPULLDOWNBAR		D Handle Row Bar ATTACHDROW		D Handle Wide Row Bar ATTACHDWROW
	Cable Curl Bar ATTACHCABLECURLBAR		25kg Weight Stack Addon for GS6/SS2 WPSCONC25		

FT-10 CABLE CROSSOVER STATION

STATIONFT10

- Weight holder compatible with 25/50mm weights.
- All parts powder-coated or chromed as protection against corrosion and scratching.
- Lower seated rows with stable footrest
- Rubberised handles for good grip
- Beginner to athlete

Includes:

- 1 x Cable pulley station (assembly set)
- 2 x Weight bracket 25mm
- 2 x Weight bracket 50mm
- 1 x Longitudinal tension rod

 75+ EXERCISES

 PULLEY WEIGHT MAX OF 100KG

 STRONG STEEL FRAME

Assembled size:
160cm x 180cm x 210cm (L x W x H)

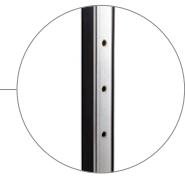

17 Vertical Notches for Height Adjustments



Horizontal Pivoting Pulley



Bottom Pulley for Seated Rows

GS-10 MULTI-FUNCTIONAL SMITH AND CABLE MACHINE

STATIONGS10

- Height adjustable cable pull
- 30/50mm weight plate compatibility
- Multi-grip positioning on chin up bar

- Weight plate storage
- Multi-functional rack with chin up and cable exercises

Assembled size:
185cm x 155cm x 225cm (L x W x H)



Pull Up Bar

Adjustable Cable Cross-over

Adjustable Cable Machine

Integrated Smith Machine

Integrated Half Rack

 4-IN-1 HOME GYM

 ADJUSTABLE J HOOKS

 100+ EXERCISES

 STRONG STEEL FRAME

ADJUSTABLE DUMBBELL PAIR

DBADJUST52.5PAIR

DBADJUST52.5PAIR-STAND

DBADJUSTSTAND

- Contoured handle for easy gripping weight system
- Stand is an optional extra
- Change weight in seconds

 ADJUSTABLE FROM 2.5KG TO 24KG

 CONTOURED HANDLE FOR EASY GRIPPING

 SMART LOCKING



Smart Locking System

With a simple weight selection dial and smart locking system, it takes seconds to pick the right weight for your workout allowing you to spend more time working out and less time switching weights.

HEX DUMBBELLS SET

DBHEXSET

Ergonomically contoured handles with knurling for grip and comfort. Included with this package, our triangular shaped stand will allow you to neatly store your dumbbells with ease. Rubber feet to stabilise and a sleek black powdercoated steel frame for durability.

 1KG-10KG PAIR SET

 STRONG DURABLE STEEL FRAME



PRO-FIXED DUMBBELLS

DBPRO2SET5-30KG

- Heavy duty commercial grade dumbbells
- Rubber pro-style with weight (kg) embossed
- Knurl grip handles
- 2-Tier dumbbell rack

 RANGE FROM 5KG TO 30KG

 12 PAIRS OF DUMBBELLS



CAST IRON KETTLEBELLS

DUMBBELLS & WEIGHTS | CAST IRON KETTLEBELLS

- Kettlebell set 4kg to 20kg KBVINYLSET4-20KG
- Kettlebell set 4kg to 12kg KBVINYLSET4-12KG
- 2-Tier kettlebell rack KETTLEBELLRACK2T



Available sizes:

- 4kg KBVINYL4
- 6kg KBVINYL6
- 8kg KBVINYL8
- 10kg KBVINYL10
- 12kg KBVINYL12
- 16kg KBVINYL16
- 20kg KBVINYL20



PREMIUM PU KETTLEBELLS

The go-to kettlebell for those looking for a durable, commercial grade kettlebell. Finished with thick moulded PU to last the distance and protect flooring or racks.

- Scratch resistant polyurethane outer shell
- Rust-free exterior that absorbs impact

Available sizes:

- 8kg KBPU008
- 10kg KBPU010
- 12kg KBPU012
- 14kg KBPU014
- 16kg KBPU016
- 20kg KBPU020
- 24kg KBPU024
- 28kg KBPU028
- 32kg KBPU032



STANDARD KETTLEBELL

Our EnduraCast kettlebells offer excellent value and come encased in heavy duty plastic for great durability. Plastic encasing minimises damage to flooring and has a smooth surface for good feel and comfortable grip.

Available sets:

- Kettlebell set 6kg to 16kg KBSTANDARDSET6-16KG
- 6kg KBSTANDARD6
- 8kg KBSTANDARD8
- 10kg KBSTANDARD10
- 12kg KBSTANDARD12
- 16kg KBSTANDARD16



HEAVY DUTY PLASTIC SHELL



COMFORTABLE GRIP



2-TIER KETTLEBELL RACK

KETTLEBELLRACK2T

Our 2-tier kettlebell rack will help store your weights and bars conveniently.



200KG MAX WEIGHT PER TIER



HEAVY DUTY STEEL CONSTRUCTION



3-TIER KETTLEBELL RACK

KBRACK3TSET

· Designed for gyms or studios, our 3-tier offers more storage for the same space.



200KG MAX WEIGHT PER TIER



HEAVY DUTY STEEL CONSTRUCTION



WEIGHTED VESTS

10KG WEIGHT VEST

WEIGHTVEST-10kg

- Small and easy to wear weight vest
- Dual front buckles for a snug fit



QUICK RELEASE BUCKLE



MESH BACK POCKET



FLEXIBLE SAND BAGS



20KG/30KG ADJUSTABLE WEIGHT VEST

- Add and remove weight bags to adjust up to 20kg or 30kg weight
- Triple velcro strap for a snug fit
- Shoulder strap buckle for easy removal

Available sizes:

- Up to 20kg WEIGHTVEST-20kg
- Up to 30kg WEIGHTVEST-30kg



OLYMPIC BARS & WEIGHTS

01 COMPETITION BUMPER PLATES

Available sizes:

- 5kg BUMPPATECOMP-05KG
- 10kg BUMPPATECOMP-10KG
- 15kg BUMPPATECOMP-15KG
- 20kg BUMPPATECOMP-20KG
- 25kg BUMPPATECOMP-25KG



DESIGNED FOR OLYMPIC LIFTING



COMMERCIAL GRADED

02 BLACK BUMPER PLATES

Available sizes:

- 5kg BUMPPATEBK-05KG
- 10kg BUMPPATEBK-10KG
- 15kg BUMPPATEBK-15KG
- 20kg BUMPPATEBK-20KG
- 25kg BUMPPATEBK-25KG



STEEL RING CORE



IWF 450MM SIZING

03 OLYMPIC TRI-GRIP

Available sizes:

- 1.25kg WPOLYTG00125X2
- 2.5kg OLYPLATE-2.5KG
- 5kg OLYPLATE-5KG
- 10kg WPOLYTG010X2
- 20kg WPOLYTG020X2



DESIGNED FOR OLYMPIC LIFTING



STEEL RING CORE

04 FRACTIONAL PLATES

WPOLYFRAC0065

- Allow for precision loading for consistent progress
- Breakthrough lifting plateaus
- Sold in pack of 6.5kg
- Breakthrough lifting plateaus
- Includes pairs of 0.25kg, 0.5kg, 1kg and 1.5kg



DESIGNED FOR OLYMPIC LIFTING



STEEL RING CORE

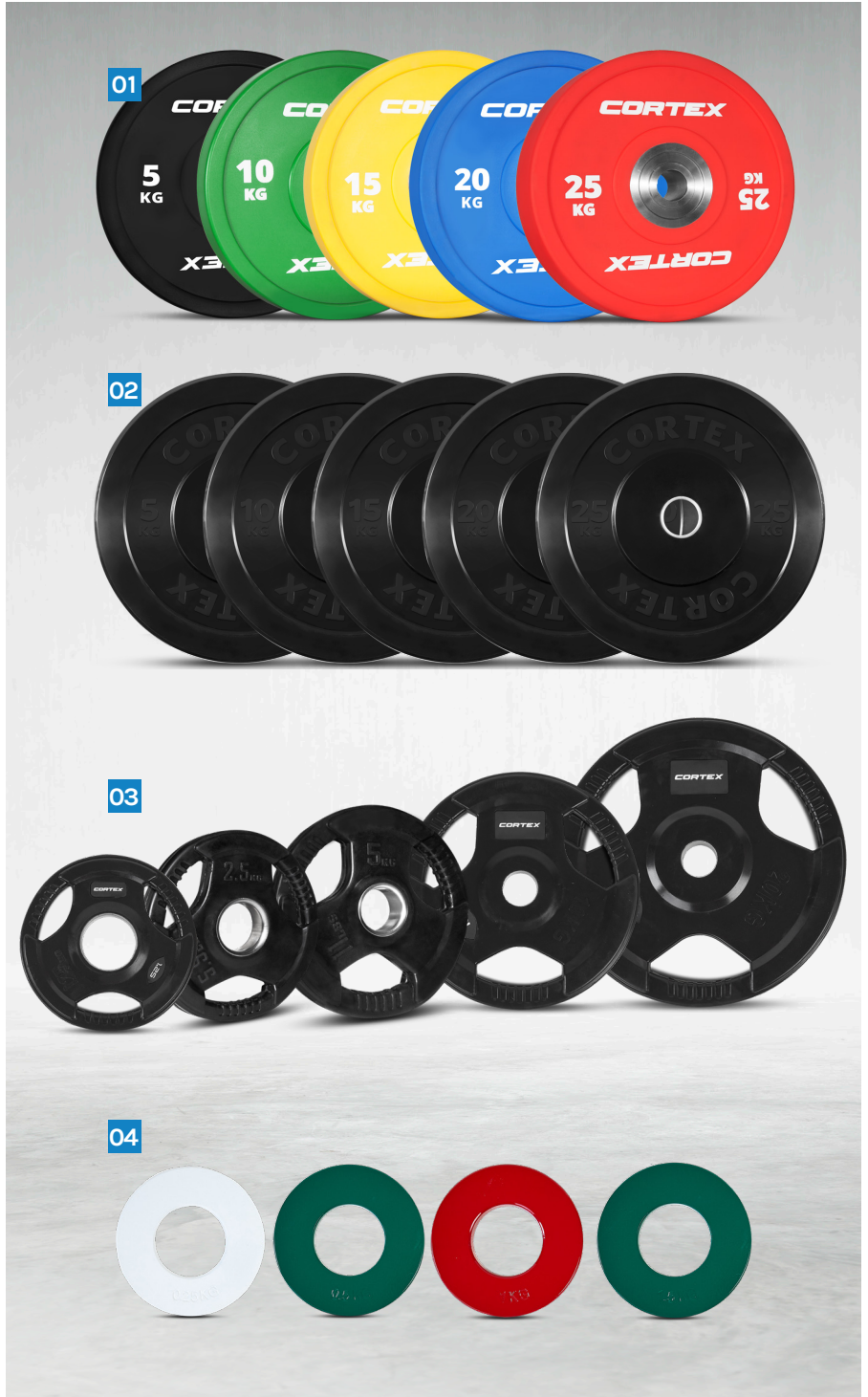

TOASTER RACK 16 PLATE

WTOLYTOAST16

- Keeps floor tidy and allows for easy access
- 16 slots to fit weight plates



HEAVY DUTY STEEL CONSTRUCTION



OLYMPIC WEIGHT TREE

WTOLYMPIC

- 3-tier weight tree
- Designed to fit plate diameter of 450mm or less
- 2x Olympic bar/barbell holders



400KG MAX WEIGHT



3 LEVELS OF OLYMPIC WEIGHT STORAGE

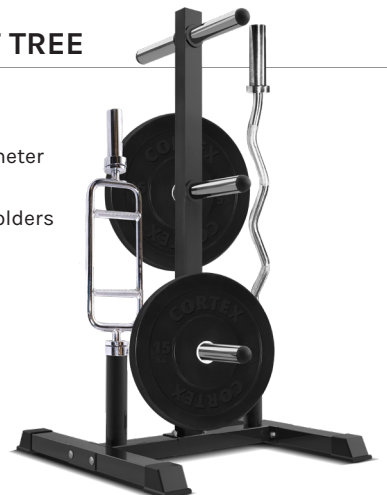

OLYMPIC BARS & ACCESSORIES

*Please refer to the website to see weight sets.

01 Olympic Tri Bar + SC
OLYBBTRISCSET

02 Olympic Dumbbell Handles + SC
OLYDBPAIRSCSET

03 Olympic Lock Jaw Collars (Pairs)
OLYCOLLARS-LOCKJAW

04 Olympic Alpha Aluminium Collars
OLYCOLLARSALU

05 Olympic Hex Bar + SC
OLYBBHEXSCSET

06 Olympic Trap Bar + SC
OLYBBTRAPSCSET

07 Olympic Multi Grip Bar + SC
OLYBBMGRSCSET

08 Olympic Swiss Bar (Multi Angle)
OLYBBSWSSCSET

09 Olympic Farmers Walk Handle (Pairs)
OLYBBFWKSCSET

10 Olympic Curl Bar 47" + SC
OLYCURBAR

11 7ft 15Kg Olympic Barbell
OLYBARBELL15SET

12 7ft 15kg Olympic Barbell
(4 Bearings / 317kg Max)
OLYBARBELL15L-SET

13 7ft Olympic Barbell
(4 Bearings / 317kg Max)
OLYBARBELL20L-SET

14 7ft Olympic Barbell
(4 Bearings / 317kg Max)
OLYBARBELL20LB-SET

15 7ft Olympic Barbell
(8 Bearings / 317kg Max)
OLYBARBELL20COMP-SET

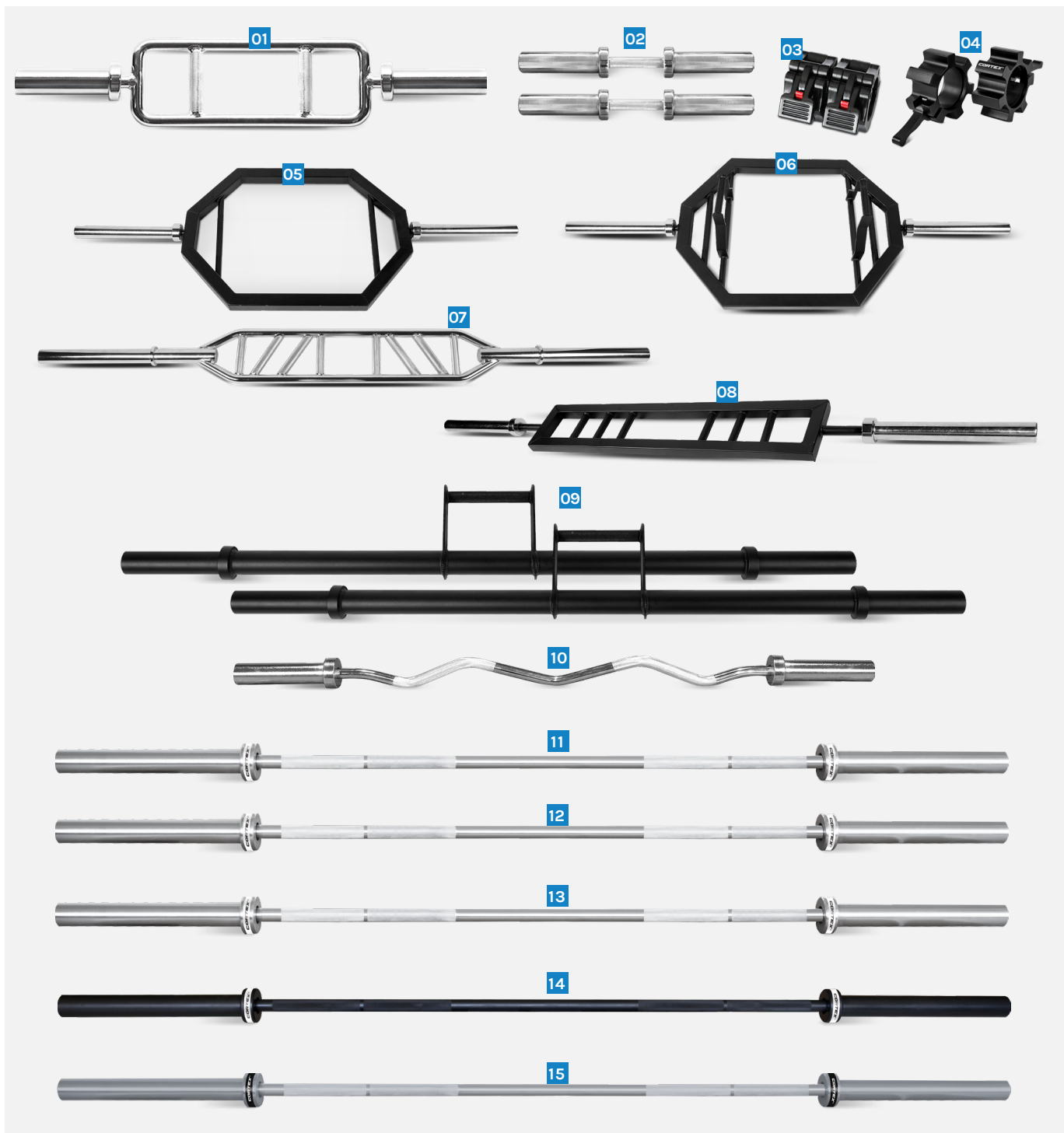

STRONGMAN LOG BARBELL

OLYBARBELLSTRONGMAN-30KG

- Centre of gravity closer to the body during lifts or rolls
- 200Kg additional
- 2x Lockjaw collars included



200KG MAX
LOADING



50MM SLEEVES



HIGH QUALITY BLACK
OXIDE COATING



PUMP STUDIO BARBELL

STUDIO-WEIGHTSET

- Studio barbell with rubber grip (35mm grip)
- 8 sided anti-roll design
- Rubber constructed
- Colour coded for different weights



30MM HOLE DIAMETER



SPRING COLLAR
CLAMPS INCLUDED



OLYMPIC WEIGHTLIFTING PLATFORM 3.0M

PLATLIFTOAK225SET

Designed to withstand repeated and heavy drops, while protecting your weights.

- High density rubber to absorb impact
- Reduces noise if weights are dropped
- High density bamboo centre platform provides great feedback to user
- Assembled size: 300cm x 200cm (L x W)



WEIGHT LIFTING CHALK

CSACHALKWL

Magnesium chalk for gym, weightlifting, kettlebell or dumbbell. Chalk reduces moisture on hands to improve your ability to maintain grip.

- Pack of 6 (360g)
- 60g each



BARBELL SQUAT PAD

BARBELLSQUATPAD

Eliminate pain from heavy, centre-knurlled barbells during squats so you can focus on your form and lift heavier without discomfort.

43CM LONG
10CM WIDE

GREAT WORKOUT
RANGE

ERGONOMICAL
DESIGN



THICK BAR GRIPS (PAIRS)

BARWEIGHTGRIPS-BLACK-PAIR

Turn any barbell or bar into a thicker 50mm diameter handle to improve grip strength and muscle activation.

50MM DIAMETER

HIGH QUALITY
RUBBER



OLYMPIC POST LANDMINE

BARBELLMINE-POST

Essential for landmine exercises which unlock a huge variety of pulling, pushing squatting, lunging and rotating in one tool.

360° RANGE
OF MOTION

FITS 50MM
OLYMPIC BARBELLS

MAX WEIGHT
LOAD: 250KG



50MM PARALLEL LANDMINE HANDLE

BARBELLMINE-PARH

Paired with the post landmine, the landmine handle unlocks rows for a killer back workout.

SEAMLESS STEEL
SLEEVES

FITS 50MM
OLYMPIC BARBELLS

STRONG STEEL
CONSTRUCTION



SINGLE ARM BARBELL JACK

BARBELLLIFTERSA

Compact single-arm deadlift barbell jack to make loading and unloading plates easier.

• Nylon wear pads protect barbell

300KG MAX WEIGHT

RAISES BARBELL
TO 310MM

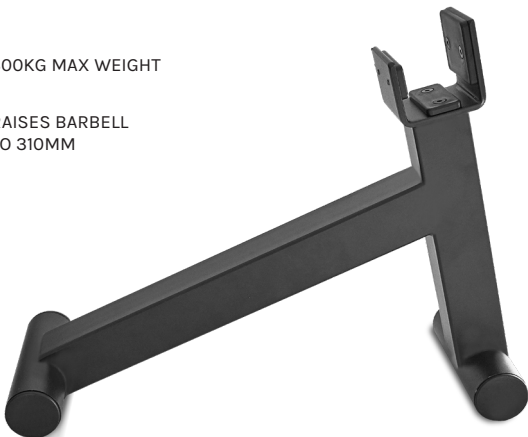

DEADLIFT BARBELL JACK

BARBELLLIFTER

Spend more energy on lifting weights and less on loading plates with our Deadlift Barbell Jack.

- Allows for easy weight racking and un-racking
- 200kg max weight
- Nylon wear pads protect barbell
- Durable steel construction

200KG MAX WEIGHT

RAISES BARBELL
TO 310MM



STANDARD BARS & WEIGHTS

01 25MM CAST IRON WEIGHTS

- Durable cast iron construction
- Reinforced core

Available sizes:

- 1.25kg WPCAST1.25-4PC
- 2.5kg WPCAST2.5-4PC
- 5kg WPCAST5-4PC
- 10kg WPCAST10-2PC



25MM HOLE DIAMETER

02 25MM CAST IRON TRI-GRIP WEIGHTS

- Tri-Grip design for easy handling
- Durable cast iron construction
- Reinforced core

Available sizes:

- 1.25kg WPSTDCASTTG00125X2
- 2.5kg WPSTDCASTTG0025X2
- 5kg WPSTDCASTTG005X2
- 10kg WPSTDCASTTG0010X2



STEEL RING CORE

03 25MM ENDURASHELL WEIGHT PLATES

Available sizes:

- 1.25kg WPCEMENT1.25
- 2.5kg WPCEMENT2.5
- 5kg WPCEMENT5
- 10kg WPCEMENT10



25MM HOLE DIAMETER

ENDURASHELL
PVC COATED**20KG STANDARD DUMBBELL SET WITH CASE**

DBSET20CASE

- Dumbbell handles with rubber grips and spiral lock collars
- Set comes with 4 x 1.25kg, 4 x 2.5kg cast iron plates
- Carry case included

DESIGNED FOR GYM
OR COMMERCIAL USE

20KG WEIGHT SET

**STANDARD WEIGHT TREE**

WTSTANDARD

- 3-Tier weight tree
- 2x Standard bar/barbell holders



200KG MAX WEIGHT

3 LEVELS OF STANDARD
WEIGHT STORAGE

STANDARD BARS

*Please refer to the website to see weight sets.

01 Standard Dumbbell Handles
DBSTANDARD14

03 Standard EZ Curl Bar
CURLBARSTD47

02 Standard Tri Bar
TRIBARSTD

04 Standard Barbell
BARBELLSTD72A

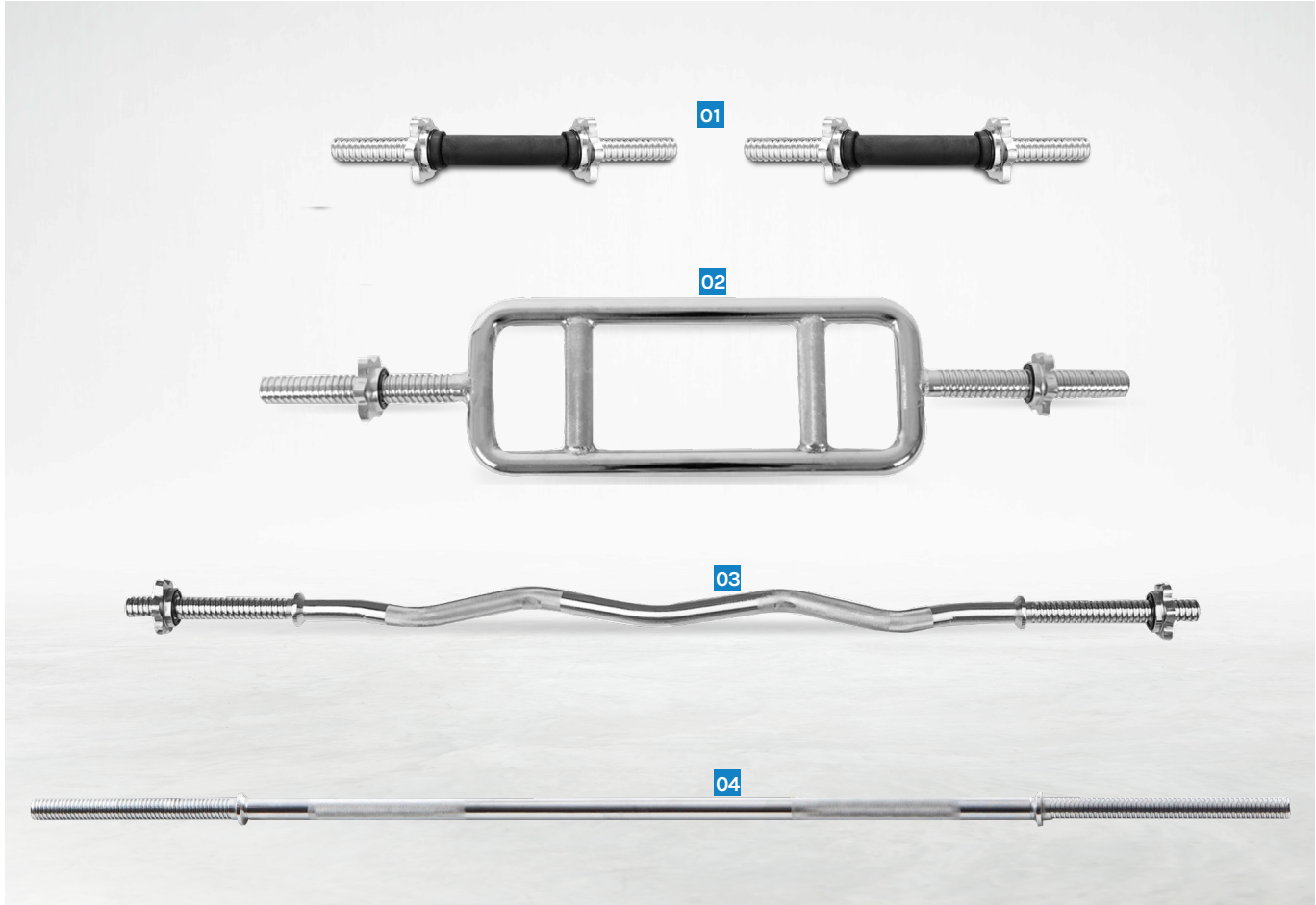

WEIGHT BALLS AND BAGS

SLAM BALL

Available sizes:

- 6kg SLAMBALL6KG
- 8kg SLAMBALL8KG
- 10kg SLAMBALL10KG
- Slam Ball complete 71kg set SLAMBALLSET71
- 12kg SLAMBALL12KG
- 15kg SLAMBALL15KG
- 20kg SLAMBALL20KG



TEXTURED PATTERN



HARD, DURABLE SHELL



SLAM BALL X

Available sizes:

- 6kg SLAMBALLX6KG
- 8kg SLAMBALLX8KG
- 10kg SLAMBALLX10KG
- 12kg SLAMBALLX12KG
- 15kg SLAMBALLX15KG
- 20kg SLAMBALLX20KG
- 25kg SLAMBALLX25KG
- 30kg SLAMBALLX30KG



STRONG TYRE
TREAD GRIP



EXTRA DURABLE SHELL



MEDICINE BALLS

Our rubber medicine balls are great for developing strength, power, endurance, and are suitable for all levels of abilities and ages.

Available sizes:

- 2kg MEDBALL2
- 4kg MEDBALL4
- 6kg MEDBALL6
- Medicine ball rack MEDBALLRACK10
- Medicine ball 30kg set MEDBALLSET30
- 8kg MEDBALL8
- 10kg MEDBALL10



COLOUR CODED



SMALL DIAMETER



WALL BALL

Great for drills to improve weightlifting movements, train strength and target multiple muscle areas.

Available sizes:

- 4kg WALLBALL-4KG
- 6kg WALLBALL-6KG
- 8kg WALLBALL-8KG
- 10kg WALLBALL-10KG
- Wall ball complete 28kg set WALLBALLSET28



COLOUR CODED



LARGE DIAMETER



POWER BAGS

Power bags are an excellent conditioning tool and the soft construction of the bag allows for a safe, effective functional way to train.

Available sizes:

- 5kg POWERBAG-5KG
- 10kg POWERBAG-10KG
- 15kg POWERBAG-15KG
- Power bag complete 75kg set POWERBAGSET75
- 20kg POWERBAG-20KG
- 25kg POWERBAG-25KG



COLOUR CODED FOR
DIFFERENT WEIGHTS



HEAVY DUTY
PU LEATHER



5-TIER POWER BAG RACK

POWERBAGRACK5

Keep your power bags stored neatly and in order with our 5-tier power bag rack.



5 TIER STORAGE



STRONG DURABLE
STEEL FRAME



PLYO BOX SET 30CM / 45CM / 60CM

The original plyometric box. Steel frame for exceptional durability and strength. Rubber slip resistant platform and rubber feet for safety and stability.

Available sizes:

- 12" (30cm) PLYOBOX30-BK
- 18" (45cm) PLYOBOX45-BK
- 24" (60cm) PLYOBOX60-BK



WOODEN 3-IN-1 MULTI PLYO BOX

PLYOBOXWOOD3IN1

- Roll over to adjust 3 different heights (51cm, 61cm, 76cm)
- Side handles for easy mobility

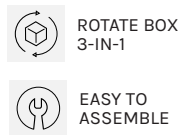

SOFT 3-IN-1 MULTI PLYO BOX

PLYOBOX-3IN1

- Capable of adjustment to 3 different heights (51cm, 61cm, 76cm), to allow for progressive exercises.
- Soft structure to cushion accidental falls
- Ultra-high density foam

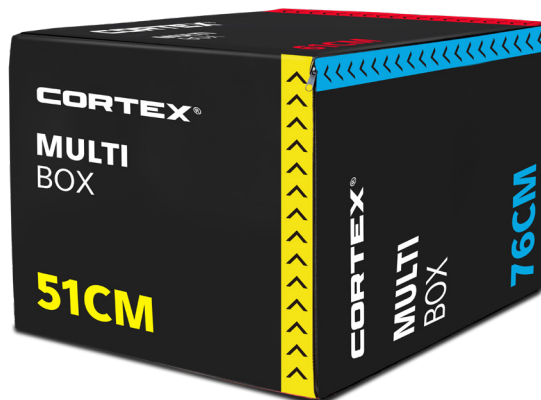
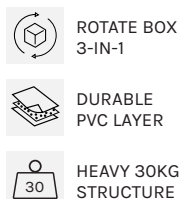

SOFT PLYO BOX SET OF 4

PLYOBOXSOFT-SET

- Set comes with 15cm, 30cm, 45cm, 60cm tall plyometric foam boxes
- Base size: 90cm x 75cm (L x W)
- Soft structure to cushion accidental falls

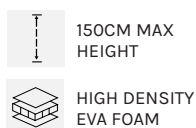

REVOBOUNCE 40 FITNESS TRAMPOLINE

TRMINI40-2

Our RevoBounce trampoline will burn heaps of calories while toning quads, glutes and calves for fun-packed aerobic workout.

- Comes with resistance bands to intensify and add variation to your workout.

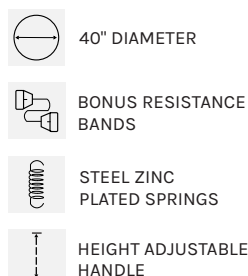

ACCESSORIES

BATTLE ROPES

ROPEBATTLE3815

- Excellent cardio workout tool
- Maximise fat burn and tone muscles



HIGH DENSITY NYLON



HEAT SHRINK HAND GRIPS



13KG TOTAL WEIGHT



PARALLEL BARS (PAIRS)

BARSPARALLEL

Simple, portable, extremely versatile and highly multi-purpose to work arms, chest, back and core muscles.



200KG MAX WEIGHT



SOFT GRIP HANDLES



SPEED SKIPPING ROPES

- Precision ball bearings and steel head
- 3m coated and adjustable cable

Available sizes:

- Black SKIPROPE-BK
- Silver SKIPROPE-SIL2



ALUMINIUM KNURL GRIPPED HANDLES



TPU COATED SKIPPING CABLE



WOODEN GYM RING (PAIRS)

GYMRING

- Crafted wooden ring and built to FIG specifications
- 4.0m long, 2.5cm wide adjustable nylon straps



400KG MAX WEIGHT



CRAFTED AND BUILT TO FIG STANDARDS



AB ROLLER WHEEL

ABROLLER

- Great for ab/core workout
- Knee pad included



ERGONOMIC RUBBER HAND GRIPS



HIGH GRADE TPE MATERIAL



LIGHTWEIGHT AND COMPACT

01 YOGA WHEEL

YOGAWHEEL-BLU

Excellent tool for stretching, great for back/shoulder/chest opening and quad/hip flex or stretching.



32CM DIAMETER
15CM WIDE



ABS PLASTIC



EVA LAYERED SHELL
DURABLE CORE

02 YOGA MAT

Our dual-layer mats are made with eco-friendly TPE, and come with a soft, comfortable surface while having a grippy, durable underside layer.

Assembled size:

183cm x 61cm x 0.5cm (L x W x H)

Available in 2 colours:

- Pink MATYOGA14PK
- Blue MATYOGA14BLU



COMPACT AND
EASY TO CARRY



DURAGRIP®
UNDERSIDE LAYER

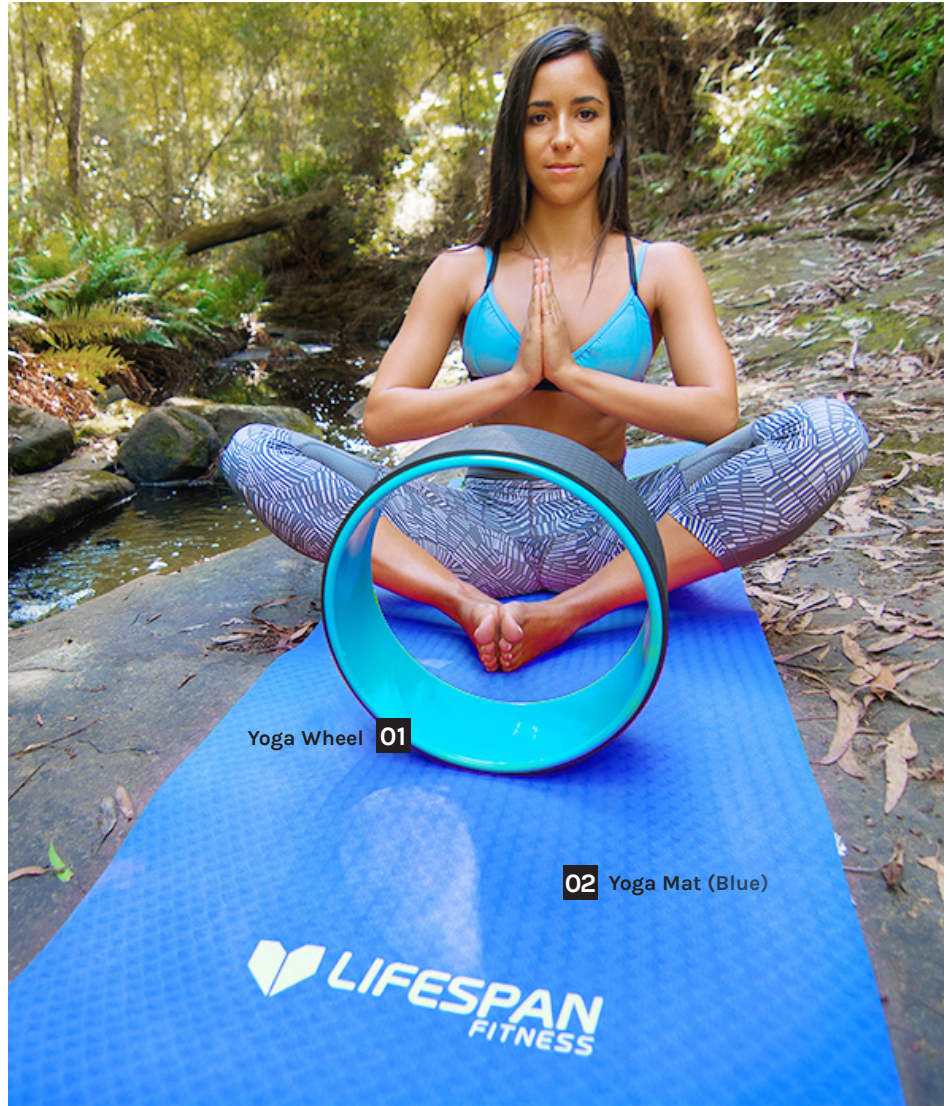

Yoga Wheel 01

02 Yoga Mat (Blue)



FOAM ROLLER

ROLLERFOAM90

- Strong core to retain shape
- High quality density EVA foam



15CM DIAMETER



90CM TOTAL LENGTH

GRID FOAM ROLLER

Grid sections with different groove patterns to allow you to vary the intensity of the pressure points.

Available sizes:

- 33cm ROLLEREVAFOAM33
- 60cm ROLLEREVAFOAM60



15CM DIAMETER



HIGH DENSITY
EVA FOAM



FOLDING EXERCISE MAT 1.8M

MATEXERFOLDING

A great accessory, perfect for any type of work or stretching routine, pilates, gymnastics and any sort of general fitness.

Assembled size: 180cm x 60cm x 5cm (L x W x H)

Folded size: 60cm x 60cm x 15cm (L x W x H)



5CM THICK
PADDED MAT



FOLDABLE



FITNESS BALL

- Anti-burst material
- Air pump included

Available sizes

- 75cm blue FITNESSBALL75
- 55cm grey FITNESSBALL55-GY
- 65cm grey FITNESSBALL65-GY
- 85cm grey FITNESSBALL85-GY





01 RESISTANCE BANDS HANDLE

BANDRESISTHANDLE

- Handles provide extra grip on pulling exercises
- Steel construction for strength and durability
- More natural grip for most movements



PRECISE KNURL GRIPPING



CHROME PLATING

02 RESISTANCE BANDS

Purchase separately or in sets:

- Set of 5 BANDRESIST-SET5
- Set of 10 BANDRESIST-SET10

Available colours and sizes

- 5mm (red) - up to 10kg resistance
- 13mm (blue) - up to 15kg resistance
- 21mm (purple) - up to 30kg resistance
- 32mm (orange) - up to 45kg resistance
- 45mm (green) - up to 60kg resistance



COLOUR CODED



MICRO FLAT RESISTANCE BANDS (PACK OF 6)

BANDRESISTO308

- Smaller diameter (50cm) than standard resistance bands
- Suited to rehabilitation and workout drills
- Range of 2.5kg to 20kg in resistance
- Pack of 6 (thickness: 0.3mm, 0.4mm, 0.5mm, 0.6mm, 0.7mm, 0.8mm)



RESISTANCE BAND & BELT HANGER

BANDHOOK16

- Lightweight Steel Construction
- Mount to reinforced wall
- 16 Hooks for belts or bands



Lifespan Fitness makes every effort to maintain the accuracy and quality of the information provided on this catalogue.

However, Lifespan Fitness cannot guarantee and assumes no legal liability or responsibility for the accuracy or completeness of the information provided. The information contained on this catalogue is for general guidance only.

The copyright of all content on this catalogue is owned by Global Fitness and Leisure and/or the various manufacturers of our equipment. No part of the Lifespan Fitness catalogue may be changed, reproduced, stored in or transmitted on any website or medium without the prior written permission of Lifespan Fitness. Requests to republish any material must be sent to info@lifespanfitness.com.au.