

ROCKY MOUNTAIN®

2020 DEALER WORKBOOK, v2.0

INTERNATIONAL - ENGLISH



Table of Contents

The 2020 Lineup	4
Product Trailmap	6
Colour Swatches	7
Technologies	8
Mountain	10
Element	11
Element Carbon XCO Edition	19
Thunderbolt	22
Instinct	34
Instinct BC Edition	45
Altitude	54
Slayer	65
Vertex	76
Fusion	83
Growler	91
Soul	99
Solo	106
Youth	110
Reaper	111
Growler Jr	118
Vertex Jr	123
Soul Jr	128
Powerplay	133
The Powerplay Advantage	134
Instinct Powerplay	136
Instinct Powerplay Alloy BC Edition	150
Altitude Powerplay	154
Contact Information	174



Rocky Mountain has been designing and developing mountain bikes in and around North Vancouver, BC since 1981. From our earliest beginnings, our bikes have been designed and tested to withstand the demanding North Shore trails. Our backyard supports our research and development process while giving us access to endless adventures and inspiration.

Between Vancouver's North Shore and Beauce, QC, we have an impressive heritage. We've built a legacy of mountain bike innovation that's core to our brand. As riders ourselves, we obsess over material quality, frame geometry, and suspension kinematics, always looking to improve the products we build, the way we work, and the way we engage our customers. If you ride the legendary trails near our North Vancouver Development Centre, it's not uncommon to run into pro riders like Thomas Vanderham and Jesse Melamed out for a rip with our engineers, testing prototype frames welded in-house in North Vancouver.

The 2020 lineup is a major milestone for Rocky Mountain. We've been working on forging new ground with our Powerplay e-MTB line, a complete redesign of the frame design of our big mountain platform, and thoughtfully designed our hardtails to get riders more comfortable out on the trail.

We're a Canadian company with a global community. Regardless of where you ride it's our goal to make sure that when you're out on the trail riding a Rocky Mountain, you love the ride.

LOVE THE RIDE

Rider:

Thomas Vanderham

Photo:

Margus Riga

Location:

France



The 2020 Lineup

MOUNTAIN

Element

DESIGNED FOR
XC

FRONT TRAVEL
120 MM

REAR TRAVEL
100 MM

WHEEL SIZE
29"



Element XCO EDITION

DESIGNED FOR
XC Race

FRONT TRAVEL
100 MM

REAR TRAVEL
100 MM

WHEEL SIZE
29"



Thunderbolt

DESIGNED FOR
Trail

FRONT TRAVEL
140 MM

REAR TRAVEL
140 MM

WHEEL SIZE
27.5 Wide Trail



Instinct

DESIGNED FOR
Trail

FRONT TRAVEL
140 MM

REAR TRAVEL
140 MM

WHEEL SIZE
29" (27.5+ ready)



Instinct BC EDITION

DESIGNED FOR
Enduro

FRONT TRAVEL
160 MM

REAR TRAVEL
155 MM

WHEEL SIZE
29" (27.5+ ready)



Altitude

DESIGNED FOR
Enduro

FRONT TRAVEL
160 MM

REAR TRAVEL
150 MM

WHEEL SIZE
27.5 Wide Trail



Slayer 29"

DESIGNED FOR
Big Mountain

FRONT TRAVEL
170 MM

REAR TRAVEL
170 MM

WHEEL SIZE
29"



Slayer 27.5"

DESIGNED FOR
Big Mountain

FRONT TRAVEL
180 MM

REAR TRAVEL
180 MM

WHEEL SIZE
27.5"



Vertex

DESIGNED FOR
XC Race

FRONT TRAVEL
100 MM

WHEEL SIZE
29" (27.5+ compatible)



Fusion

DESIGNED FOR
Sport XC

FRONT TRAVEL
100 MM

WHEEL SIZE
29"



Growler

DESIGNED FOR
Trail

FRONT TRAVEL
130 & 140 MM

WHEEL SIZE
29 Wide Trail



Soul

DESIGNED FOR
Sport Trail

FRONT TRAVEL
120 MM

WHEEL SIZE
27.5"



Solo

DESIGNED FOR
Adventure

WHEEL SIZE
700c & 650b



YOUTH

Reaper

DESIGNED FOR
Youth Trail

FRONT TRAVEL
120 & 130 MM

REAR TRAVEL
130 MM

WHEEL SIZE
24, 26, & 27.5"



Growler Jr

DESIGNED FOR
Youth Trail

FRONT TRAVEL
80 & 100 MM

WHEEL SIZE
24+ & 26+



Vertex Jr

DESIGNED FOR
Youth XC

FRONT TRAVEL
65 MM

WHEEL SIZE
20 & 24"



Soul Jr

DESIGNED FOR
Youth Trail

FRONT TRAVEL
63 MM

WHEEL SIZE
20 & 24"



POWERPLAY

Instinct PP

DESIGNED FOR
Trail

FRONT TRAVEL
140 MM

REAR TRAVEL
140 MM

WHEEL SIZE
29" (27.5+ ready)



Instinct PP BC EDITION

DESIGNED FOR
Aggressive Trail

FRONT TRAVEL
160 MM

REAR TRAVEL
155 MM

WHEEL SIZE
29" (27.5+ ready)



Altitude PP

DESIGNED FOR
Aggressive Trail

FRONT TRAVEL
160 MM

REAR TRAVEL
150 MM

WHEEL SIZE
27.5 Wide Trail



Product Trailmap

Our engineering and product teams are hard at work designing Rocky Mountain's next generation of bikes. Please keep in mind this is a development trail map only to help give you a peek at what is to come; product delivery may be adjusted based on testing and parts availability. We appreciate you keeping these platforms and availability windows confidential.

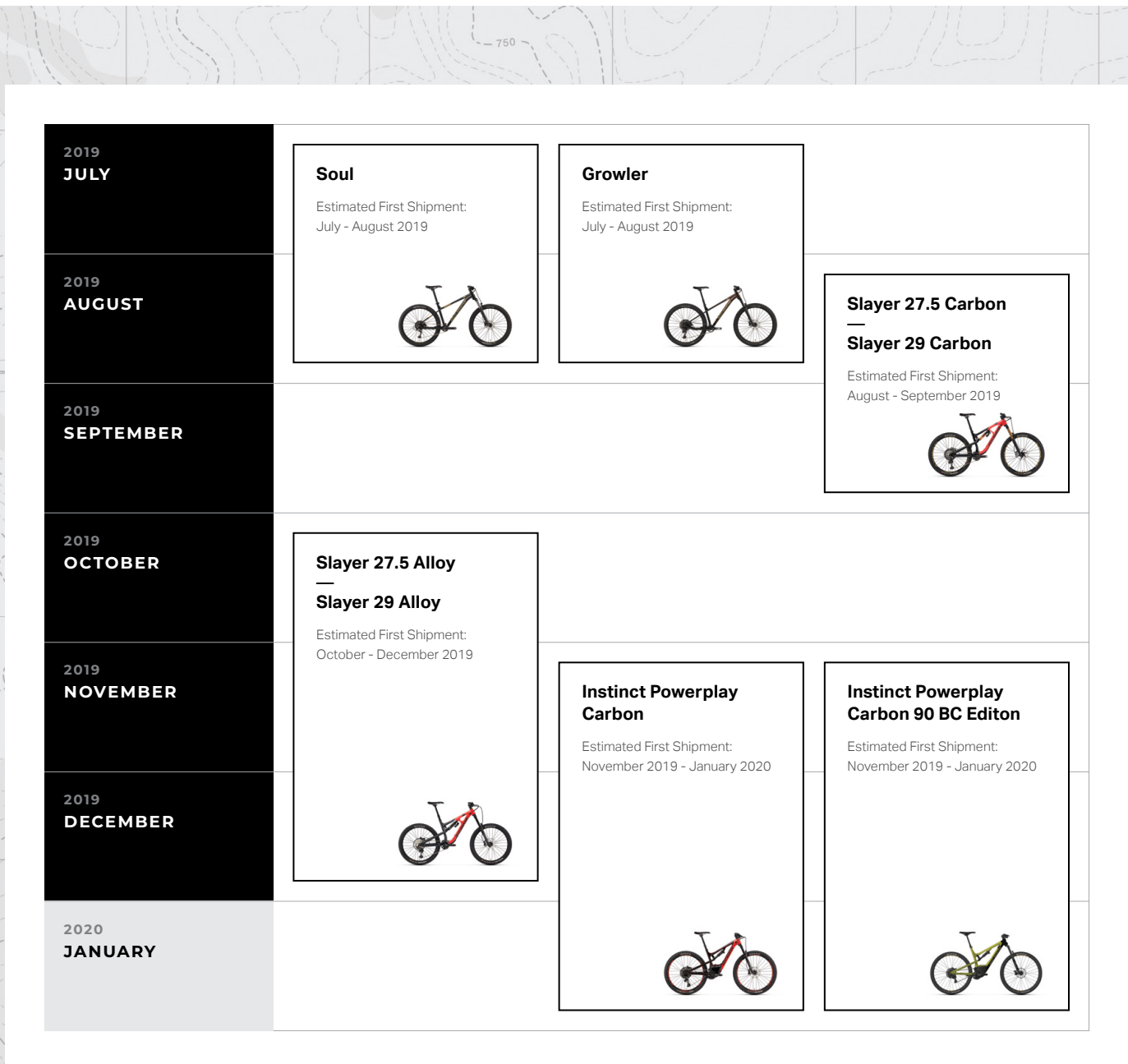

Colour Swatches

ZOMBIE <i>NEW FOR MY20</i>	BRASS MONKEY <i>NEW FOR MY20</i>	BROWN SUGAR	RUSTY CAGE
YELLOW SUBMARINE <i>NEW FOR MY20</i>	SCHOOL'S OUT	FOX RACING ORANGE	VOLCANO <i>NEW FOR MY20</i>
HAZZARD	FLAMING LIPS	SUNDAY BLOODY SUNDAY	HEARTBREAKER <i>NEW FOR MY20</i>
PURPLE RAIN	DEEP PURPLE	FOLSOM PRISON BLUE	BLUE MONDAY
NEVERMIND <i>NEW FOR MY20</i>	BILLY OCEAN	SURFIN' BIRD	ACID RAIN
POISON <i>NEW FOR MY20</i>	TANK GIRL	DEEP DARK WOODS <i>NEW FOR MY20</i>	SPACE ODDITY
THE MAN IN BLACK	BACK IN BLACK	SMOKE ON THE WATER	TOUCH OF GREY
UD CARBON <i>NEW FOR MY20</i>			

Technologies

Rider:

Rémi Gauvin

Photo:

Dave Trumppore

Location:

Tasmania

RIDE-9

ADJUSTMENT SYSTEM

The RIDE-9 adjustment system allows riders to quickly fine-tune their geometry and suspension with a pair of Allen keys. Nine configurations are possible thanks to two interlocking chips.

RIDE-4

ADJUSTMENT SYSTEM

The RIDE-4 adjustment system allows riders to quickly fine-tune their geometry with a pair of Allen keys. Four configurations are possible thanks to one rotating chip. This allows for subtle geometry changes with minimal effect on your shock tune.

Smoothwall Carbon

FRAME MATERIAL

Smoothwall carbon uses one of the world's most sophisticated carbon processes to deliver industry leading stiffness-to-weight, ride quality, and durability. We eliminate excess resin and fibers by using rigid internal molds instead of traditional air bladders. We then utilize different types of carbon in specific frame areas to maximize stiffness and impact resistance while minimizing overall weight.

FORM Alloy

FRAME MATERIAL

FORM tubesets utilize premium materials to meet our strict requirements. Each FORM tube that we create is engineered for its specific purpose within the frame, ensuring optimized strength, weight, and ride quality.

**RMB 6061**

ALLOY

RMB 6061 custom alloy balances strength, weight, and value. The heart of every bike is its frame, and this tubing allows us to produce a high quality frame in an economical package.

**Smoothlink**

SUSPENSION

Smoothlink suspension is efficient yet supple when you're on the pedals and across a wide range of gears. It features a controlled end-stroke and a rate-curve that feels more capable than the travel would suggest. This four-bar suspension design philosophy is centred on ride characteristics; each bike platform we develop balances variables like anti-squat, axle path, chain growth, rate curve, anti-rise, etc. to achieve the legendary Rocky Mountain ride feel.

**Size Specific**

TUNE

Size Specific Tune ensures that riders of all sizes get the right balance of small-bump compliance, mid-stroke support, and end-stroke progressiveness. Our design team does custom shock tunes based on real world field testing, and adjusts each tune for specific frame sizes.

**Pipelock**

COLLETS

Pipelock collets expand radially and lock into the frame, creating the widest and most rigid pivot stance possible. Using Pipelock collets allows us to lower our front triangle pivot-weights while maximizing lateral stiffness.

**Dynamo 3.0**

DRIVE SYSTEM

Designed in Canada, in collaboration with Propulsion Powercycle, the Dynamo 3.0 drive system is a sleek, lightweight, and powerful electric assist that pushes the boundaries of electric bikes. Its compact, low-mounted motor allows us to design electric mountain bikes to our suspension and handling standards—with proper geometry and ideal pivot placement. The system provides class-leading power, instant response, and super-fast charging.

For riders who carve corners, attack technical trail features, and grind out epic climbs, we design bikes for that perfect ride feel. We believe in continuously improving our products and are not afraid to carve our own path and sweat every detail. We want to make sure that you enjoy riding our bikes as much as we do!

Mountain

A mountain biker wearing a blue helmet, dark jacket, and backpack is riding a blue Rocky Mountain mountain bike on a rocky, mossy trail. The bike has "ROCKY MOUNTAIN" written on the frame and "MAXXIS" on the tires. The rider is leaning forward, navigating a technical section of the trail. The background is a blurred, rocky landscape.

Rider:
Thomas Vanderham

Photo:
Ross Bell

Location:
Ecuador

ELEMENT

DESIGNED FOR
XC

FRONT TRAVEL
120 MM

REAR TRAVEL
100 MM

WHEEL SIZE
29"

Be in your Element. From stage wins and multi-day rides to the top step of the BC Bike Race; this is the result of over two decades at the front of the pack.

The Element features efficient suspension performance, refined geometry, RIDE-9 adjustability, and room for two bottles inside the front triangle. Now available in both carbon and alloy models, the smallest details were examined in the search of weight savings, point-n-shoot rigidity, and unrivaled speed.

NOTES

Rider:
Quinn Moberg

Photo:
Margus Riga

Location:
BCBR, British Columbia

FRAME TECHNOLOGY



Smoothwall Carbon
FRAME MATERIAL



RIDE-9
ADJUSTMENT SYSTEM



Smoothlink
SUSPENSION



Size Specific
TUNE



ELEMENT CARBON

GEOMETRY

Geometry shown for Slack, Neutral, and Steep RIDE-9™ positions.

- HTA** Head Tube Angle (deg)
- STA** Seat Tube Angle (deg)
- STL** Seat Tube Length (mm)
- TTH** Top Tube Horizontal (mm)
- HTL** Head Tube Length (mm)
- RC** Rear Centre (mm)
- BBD** Bottom Bracket Drop (mm)
- SH** Standover Height (mm)
- WB** Wheelbase (mm)
- R** Reach (mm)
- S** Stack (mm)

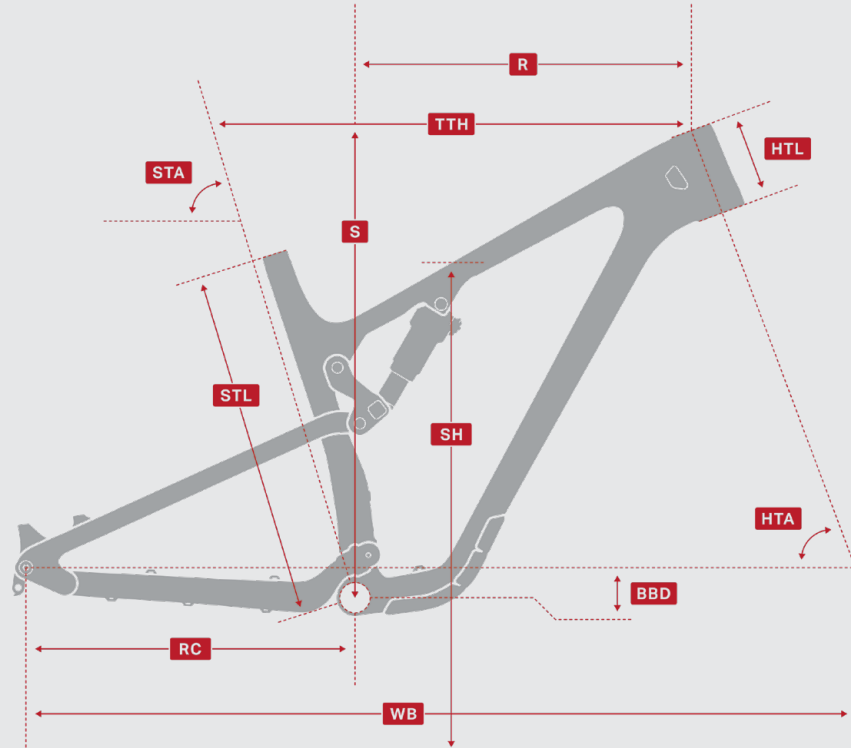

	SM			MD			LG			XL			XXL		
	Slack	Neutral	Steep	Slack	Neutral	Steep	Slack	Neutral	Steep	Slack	Neutral	Steep	Slack	Neutral	Steep
HTA	68.6°	69.2°	69.8°	68.7°	69.2°	69.8°	68.7°	69.2°	69.8°	68.7°	69.2°	69.8°	68.7°	69.2°	69.8°
STA	74.1°	74.7°	75.3°	74.2°	74.7°	75.3°	74.2°	74.7°	75.3°	74.2°	74.7°	75.3°	74.2°	74.7°	75.3°
STL	394	394	394	432	432	432	470	470	470	508	508	508	546	546	546
TTH	567	566	564	592	591	589	617	616	614	648	646	644	668	666	664
HTL	93	93	93	103	103	103	118	118	118	128	128	128	143	143	143
RC	439	438	437	439	438	437	439	438	437	439	438	437	439	438	437
BBD	44	38	31	44	38	31	45	38	31	45	38	31	45	38	31
SH	821	823	825	819	821	823	820	822	824	817	820	822	819	821	824
WB	1109	1109	1108	1135	1135	1134	1161	1161	1160	1192	1192	1191	1214	1214	1213
R	395	401	407	418	424	430	439	445	451	467	472	478	483	489	495
S	606	602	598	615	611	607	630	625	621	639	635	630	653	649	644

ELEMENT CARBON COLOURWAYS

Carbon 90 / 70 / 50

COLOUR 1

Element Carbon 90 shown



UD CARBON
GLOSS

FLAMING LIPS
GLOSS

Carbon 90 / 70

COLOUR 2

Element Carbon 90 shown



THE MAN IN BLACK
GLOSS

FOX RACING ORANGE
GLOSS

ELEMENT CARBON COLOURWAYS

Carbon Frameset

COLOUR 1



UD CARBON
GLOSS

FLAMING LIPS
GLOSS

Carbon Frameset

COLOUR 2



THE MAN IN BLACK
GLOSS

FOX RACING ORANGE
GLOSS

B0001

MSRP

Element Carbon 90

MODEL HIGHLIGHTS

- Multi day marathon race spec
- Capable short travel trail bike
- Full carbon frame
- RIDE-9 Geometry adjustment tailors bike to suit the rider & terrain

IMPROVEMENTS OVER PREVIOUS MODEL

- 120mm 34 Step Cast fork
- Race Face Next SL cranks
- Wider tires for improved grip

COLOUR 1



UD CARBON
GLOSS

FLAMING LIPS
GLOSS

COLOUR 2



THE MAN IN BLACK
GLOSS

FOX RACING ORANGE
GLOSS

Front Triangle

Smoothwall Carbon. Full Sealed Cartridge Bearings. Press Fit BB. Internal Cable Routing. RIDE-9 Adjustable Geometry + Suspension Rate. 100mm Travel.

Chainstay

Smoothwall Carbon

Seatstay

Smoothwall Carbon

Fork

Fox 34 Step Cast Float Factory 120mm

Rear Shock

Fox Float DPS Factory

F / Brake

Shimano XTR

R / Brake

Shimano XTR

F / Rotor

Shimano RT86 180mm

R / Rotor

Shimano RT86 160mm

R / Shifter

Shimano XTR

R / Derailleur

Shimano XTR

Crankset

Race Face Next SL Cinch 32T

Bottom Bracket

Race Face BB92 30mm

Cassette

Shimano XTR 12s 10-51T

Chain

Shimano XTR 12s

F / Hub

Rocky Mountain Sealed Boost 15mm

R / Hub

DT Swiss 350 Boost 148mm

Spokes

DT Swiss Competition 2.0/1.8/2.0

F / Rim

Race Face ARC 25

R / Rim

Race Face ARC 25

F / Rim Tape

Tubeless Ready - Tape / Valves Incl.

R / Rim Tape

Tubeless Ready - Tape / Valves Incl.

F / Tire

Maxxis Ikon Maxx Speed 3C
Tubeless Ready 29 x 2.35

R / Tire

Maxxis Ikon Maxx Speed 3C
Tubeless Ready 29 x 2.35

Headset

FSA Orbit NO.57E

Stem

Rocky Mountain 35 CNC

Handlebar

Race Face Next 760mm

Grips / Tape

Rocky Mountain Lock On XC

Seatpost

Fox Transfer Factory Series 30.9mm

Saddle

WTB Silverado Race 142

B0002

MSRP

Element Carbon 70

MODEL HIGHLIGHTS

- Multi day marathon race spec
- Capable short travel trail bike
- Full carbon frame
- RIDE-9 Geometry adjustment tailors bike to suit the rider & terrain

IMPROVEMENTS OVER PREVIOUS MODEL

- Uncluttered cockpit by deleting remote
- New 12spd Shimano drivetrain
- Wider tires for improved grip

COLOUR 1



UD CARBON
GLOSS

FLAMING LIPS
GLOSS

COLOUR 2



THE MAN IN BLACK
GLOSS

FOX RACING ORANGE
GLOSS

Front Triangle	Smoothwall Carbon. Full Sealed Cartridge Bearings. Press Fit BB. Internal Cable Routing. RIDE-9 Adjustable Geometry + Suspension Rate. 100mm Travel.
Chainstay	Smoothwall Carbon
Seatstay	Smoothwall Carbon
Fork	Fox 34 Step Cast Float Performance Elite 120mm
Rear Shock	Fox Float DPS Performance Elite
F / Brake	Shimano XT
R / Brake	Shimano XT
F / Rotor	Shimano RT66 180mm
R / Rotor	Shimano RT66 160mm
R / Shifter	Shimano XT
R / Derailleur	Shimano XTR
Crankset	Race Face Turbine Cinch 32T
Bottom Bracket	Race Face BB92 30mm
Cassette	Shimano XT 10-51T
Chain	Shimano HG8100
F / Hub	Rocky Mountain Sealed Boost 15mm
R / Hub	DT Swiss 370 Boost 148mm
Spokes	DT Swiss Competition 2.0/1.8/2.0
F / Rim	Race Face AR 25
R / Rim	Race Face AR 25
F / Rim Tape	Tubeless Ready - Tape / Valves Incl.
R / Rim Tape	Tubeless Ready - Tape / Valves Incl.
F / Tire	Maxxis Ikon Tubeless Ready 29 x 2.35
R / Tire	Maxxis Ikon Tubeless Ready 29 x 2.35
Headset	FSA Orbit NO.57E
Stem	Rocky Mountain 35 AM
Handlebar	Race Face Turbine 760mm
Grips / Tape	Rocky Mountain Lock On XC
Seatpost	Race Face Turbine R (by Fox) Dropper 30.9mm
Saddle	WTB Silverado Race 142

B0004

MSRP

Element Carbon 50

MODEL HIGHLIGHTS

- Multi day marathon race spec
- Capable short travel trail bike
- Full carbon frame
- RIDE-9 Geometry adjustment tailors bike to suit the rider & terrain

IMPROVEMENTS OVER PREVIOUS MODEL

- Full carbon frame
- New 12spd Shimano drivetrain
- Race Face dropper post

COLOUR 1



UD CARBON
GLOSS

FLAMING LIPS
GLOSS

Front Triangle

Smoothwall Carbon. Full Sealed Cartridge Bearings. Press Fit BB. Internal Cable Routing. RIDE-9 Adjustable Geometry + Suspension Rate. 100mm Travel.

Chainstay

Smoothwall Carbon

Seatstay

Smoothwall Carbon

Fork

Fox 34 Step Cast Float Performance 120mm

Rear Shock

Fox Float DPS Performance

F / Brake

Shimano SLX

R / Brake

Shimano SLX

F / Rotor

Shimano RT66 180mm

R / Rotor

Shimano RT66 160mm

R / Shifter

Shimano SLX

R / Derailleur

Shimano XT

Crankset

Race Face Aeffect Cinch 32T Steel

Bottom Bracket

Shimano SM-BBMT500

Cassette

Shimano SLX 10-51T

Chain

Shimano HG7100

F / Hub

Rocky Mountain Sealed Boost 15mm

R / Hub

DT Swiss 370 Boost 148mm

Spokes

DT Swiss Competition 2.0/1.8/2.0

F / Rim

WTB ST Light i25 TCS 2.0 Tubeless

R / Rim

WTB ST Light i25 TCS 2.0 Tubeless

F / Rim Tape

Tubeless Ready - Tape / Valves Incl.

R / Rim Tape

Tubeless Ready - Tape / Valves Incl.

F / Tire

Maxxis Ikon Tubeless Ready 29 x 2.35

R / Tire

Maxxis Ikon Tubeless Ready 29 x 2.35

Headset

FSA Orbit NO.57E

Stem

Rocky Mountain AM

Handlebar

Rocky Mountain Flat Top 760mm

Grips / Tape

Rocky Mountain Lock On XC

Seatpost

Race Face Aeffect R Dropper 30.9mm

Saddle

WTB Silverado Race 142

F0001

MSRP

Element Carbon FRAMESET

MODEL HIGHLIGHTS

- 100mm Travel XC frame
- Compatible with 100-120mm forks
- Full carbon frame
- RIDE-9 Geometry adjustment tailors bike to suit the rider & terrain

COLOUR 1



UD CARBON
GLOSS

FLAMING LIPS
GLOSS

COLOUR 2



THE MAN IN BLACK
GLOSS

FOX RACING ORANGE
GLOSS

Front Triangle

Smoothwall Carbon. Full Sealed Cartridge Bearings. Press Fit BB. Internal Cable Routing. RIDE-9 Adjustable Geometry + Suspension Rate. 100mm Travel.

Chainstay

Smoothwall Carbon

Seatstay

Smoothwall Carbon

Rear Shock

Fox Float DPS Factory

Headset

FSA Orbit NO.57E Extend-o-matic



ELEMENT XCO EDITION

DESIGNED FOR
XC Race

WHEEL SIZE
29"

FRONT TRAVEL
100 MM

REAR TRAVEL
100 MM

Arms up over the line.

Designed to excel at the pinnacle of short track racing, the Element XCO Edition features a special build for even more aggressive XC race geometry and lighter weight.

GEOMETRY

Geometry shown for Slack, Neutral, and Steep RIDE-9 positions.

- HTA** Head Tube Angle (deg)
- STA** Seat Tube Angle (deg)
- STL** Seat Tube Length (mm)
- TTH** Top Tube Horizontal (mm)
- HTL** Head Tube Length (mm)
- RC** Rear Centre (mm)
- BBD** Bottom Bracket Drop (mm)
- SH** Standover Height (mm)
- WB** Wheelbase (mm)
- R** Reach (mm)
- S** Stack (mm)

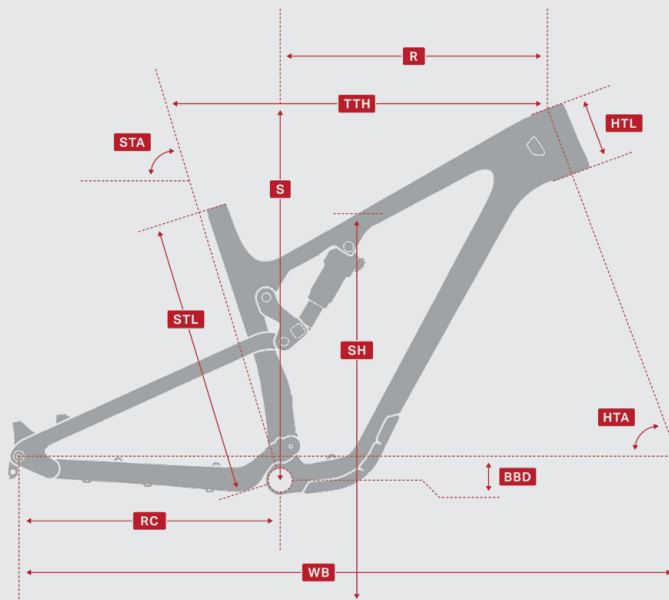

	SM			MD			LG			XL			XXL		
	Slack	Neutral	Steep	Slack	Neutral	Steep	Slack	Neutral	Steep	Slack	Neutral	Steep	Slack	Neutral	Steep
HTA	69.3°	69.8°	70.4°	69.3°	69.8°	70.4°	69.3°	69.8°	70.4°	69.3°	69.8°	70.4°	69.3°	69.8°	70.4°
STA	74.8°	75.3°	75.9°	74.8°	75.3°	75.9°	74.8°	75.3°	75.9°	74.8°	75.3°	75.9°	74.8°	75.3°	75.9°
STL	394	394	394	432	432	432	470	470	470	508	508	508	546	546	546
TTH	566	564	563	591	589	588	616	614	613	646	644	642	666	664	662
HTL	93	93	93	103	103	103	118	118	118	128	128	128	143	143	143
RC	439	438	437	439	438	437	439	438	437	439	438	437	439	438	437
BBD	49	43	36	49	43	36	49	43	35	49	42	35	49	42	35
SH	810	812	814	809	811	813	810	812	814	808	810	813	809	812	815
WB	1104	1104	1103	1130	1130	1129	1157	1156	1156	1188	1187	1187	1209	1209	1208
R	402	408	414	425	430	436	446	452	458	473	479	485	490	495	501
S	601	597	593	611	607	602	625	621	616	634	630	625	648	644	639

ELEMENT CARBON COLOURWAYS

Carbon 70 XCO Edition

COLOUR 1



UD CARBON
GLOSS

FLAMING LIPS
GLOSS

Carbon 70 XCO Edition

COLOUR 2



THE MAN IN BLACK
GLOSS

FOX RACING ORANGE
GLOSS

B0003

MSRP

Element Carbon 70 XCO EDITION

MODEL HIGHLIGHTS

- Short track cross country race spec
- Full carbon frame
- All new Shimano XT / XTR 12spd drivetrain
- RIDE-9 Geometry adjustment tailors bike to suit the rider & terrain

COLOUR 1



UD CARBON
GLOSS

FLAMING LIPS
GLOSS

COLOUR 2



THE MAN IN BLACK
GLOSS

FOX RACING ORANGE
GLOSS

Front Triangle

Smoothwall Carbon. Full Sealed Cartridge Bearings. Press Fit BB. Internal Cable Routing. RIDE-9 Adjustable Geometry + Suspension Rate. 100mm Travel.

Chainstay

Smoothwall Carbon

Seatstay

Smoothwall Carbon

Fork

Fox 32 Step Cast Performance 100mm

Rear Shock

Fox Float DPS Remote Performance Elite

F / Brake

Shimano XT

R / Brake

Shimano XT

F / Rotor

Shimano RT66 180mm

R / Rotor

Shimano RT66 160mm

R / Shifter

Shimano XT

R / Derailleur

Shimano XTR

Crankset

Race Face Next SL Cinch 32T Steel

Bottom Bracket

Race Face BB92 30mm

Cassette

Shimano XT 10-51T

Chain

Shimano HG8100

F / Hub

Rocky Mountain Sealed Boost 15mm

R / Hub

DT Swiss 370 Boost 148mm

Spokes

DT Swiss Competition 1.8/1.6/1.8

F / Rim

Rocky Mountain 24XC Carbon Tubeless Ready

R / Rim

Rocky Mountain 24XC Carbon Tubeless Ready

F / Rim Tape

Tubeless Ready - Tape / Valves Incl.

R / Rim Tape

Tubeless Ready - Tape / Valves Incl.

F / Tire

Maxxis Rekon Maxx Speed 3C
Tubeless Ready 29 x 2.25

R / Tire

Maxxis Rekon Race Dual Compound
Tubeless Ready 29 x 2.25

Headset

FSA Orbit NO.57E Extend-o-matic

Stem

Rocky Mountain AM

Handlebar

Rocky Mountain Flat Top 760mm

Grips / Tape

Rocky Mountain Lock On XC

Seatpost

Rocky Mountain Carbon SL 30.9mm

Saddle

WTB Silverado Race 142

THUNDERBOLT

DESIGNED FOR

Trail

FRONT TRAVEL

140 MM

REAR TRAVEL

140 MM

WHEEL SIZE

27.5 Wide Trail

Fast as lightning!

Quick and nimble, the Thunderbolt is total livewire. Whether it's powering up technical climbs or popping off every trail feature in sight, its 27.5" wheels and 140mm of rear travel makes this bike ready and capable for when you're feeling creative with line choice. The frame is available in both carbon and alloy, and our RIDE-9 adjustment system gives you the power to further adjust geometry and ride characteristics to your liking.





NOTES

Rider:
Justin Roy

Photo:
Margus Riga

Location:
Whistler, BC

FRAME TECHNOLOGY

-  **Smoothwall Carbon**
FRAME MATERIAL
-  **FORM Alloy**
FRAME MATERIAL
-  **RIDE-9**
ADJUSTMENT SYSTEM
-  **Smoothlink**
SUSPENSION
-  **Size Specific**
TUNE



THUNDERBOLT CARBON & ALLOY

GEOMETRY

Geometry shown for Slack, Neutral, and Steep RIDE-9™ positions.

- HTA** Head Tube Angle (deg)
- STA** Seat Tube Angle (deg)
- STL** Seat Tube Length (mm)
- TTH** Top Tube Horizontal (mm)
- HTL** Head Tube Length (mm)
- RC** Rear Centre (mm)
- BBD** Bottom Bracket Drop (mm)
- SH** Standover Height (mm)
- WB** Wheelbase (mm)
- R** Reach (mm)
- S** Stack (mm)

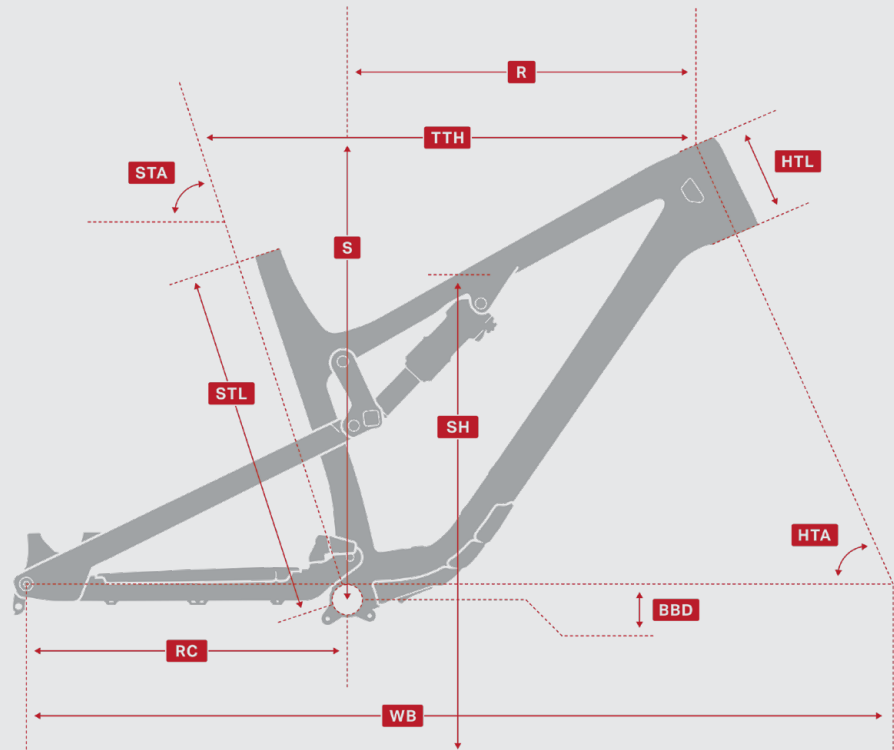

	XS			SM			MD			LG			XL		
	<i>Slack</i>	<i>Neutral</i>	<i>Steep</i>	<i>Slack</i>	<i>Neutral</i>	<i>Steep</i>	<i>Slack</i>	<i>Neutral</i>	<i>Steep</i>	<i>Slack</i>	<i>Neutral</i>	<i>Steep</i>	<i>Slack</i>	<i>Neutral</i>	<i>Steep</i>
HTA	65.9°	66.6°	67.1°	65.9°	66.6°	67.1°	65.9°	66.6°	67.1°	65.9°	66.6°	67.1°	65.9°	66.6°	67.1°
STA	73.9°	74.6°	75.1°	73.9°	74.6°	75.1°	73.9°	74.6°	75.1°	73.9°	74.6°	75.1°	73.9°	74.6°	75.1°
STL	356	356	356	394	394	394	432	432	432	471	471	471	509	509	509
TTH	548	546	545	578	576	575	603	601	600	628	626	625	658	656	655
HTL	100	100	100	110	110	110	120	120	120	130	130	130	145	145	145
RC	426	425	424	426	425	424	426	425	424	426	425	424	426	425	424
BBD	24	17	10	24	17	10	24	17	10	24	17	10	24	17	10
SH	799	802	804	799	802	804	799	802	804	799	802	804	799	802	804
WB	1104	1103	1102	1136	1135	1134	1162	1161	1160	1189	1188	1186	1221	1220	1219
R	380	386	392	408	414	419	430	436	442	453	459	464	479	485	491
S	583	579	575	593	588	584	602	598	593	611	607	603	626	621	616

THUNDERBOLT CARBON COLOURWAYS

Carbon 90 / 70 / 50

COLOUR 1

Thunderbolt Carbon 90 shown



POISON
GLOSS

THE MAN IN BLACK
MATTE

BACK IN BLACK
GLOSS

Carbon 90 / 70 / 50

COLOUR 2

Thunderbolt Carbon 90 shown



SPACE ODDITY
GLOSS

THE MAN IN BLACK
MATTE

BACK IN BLACK
GLOSS

THUNDERBOLT CARBON COLOURWAYS

Carbon Frameset

COLOUR 1



POISON
GLOSS

THE MAN IN BLACK
MATTE

BACK IN BLACK
GLOSS

Carbon Frameset

COLOUR 2



SPACE ODDITY
GLOSS

THE MAN IN BLACK
MATTE

BACK IN BLACK
GLOSS

B0007

MSRP

Thunderbolt Carbon 90

MODEL HIGHLIGHTS

- The Thunderbolt strikes that perfect balance between quickness and surefootedness
- Mid Travel 140mm for quick, playful feel
- Full Carbon frame
- RIDE-9 Geometry adjustment tailors bike to suit the rider & terrain

IMPROVEMENTS OVER PREVIOUS MODEL

- Short offset fork for high speed stability
- Upgraded spec across the board
- Wider rims and tires for increased control

COLOUR 1



POISON
GLOSS

THE MAN IN BLACK
MATTE

BACK IN BLACK
GLOSS

COLOUR 2



SPACE ODDITY
GLOSS

THE MAN IN BLACK
MATTE

BACK IN BLACK
GLOSS

Front Triangle

Smoothwall Carbon. Full Sealed Cartridge Bearings. Press Fit BB. Internal Cable Routing. 2-Bolt ISCG05 Tabs. RIDE-9 Adjustable Geometry + Suspension Rate. 140mm Travel.

Chainstay

Smoothwall Carbon

Seatstay

Smoothwall Carbon

Fork

Fox 34 Float Factory 140mm 37mm Offset

Rear Shock

Fox Float DPS EVOL Factory

F / Brake

Shimano XTR

R / Brake

Shimano XTR

F / Rotor

Shimano RT86 180mm

R / Rotor

Shimano RT86 180mm

R / Shifter

Shimano XTR

R / Derailleur

Shimano XTR

Crankset

Race Face Next R Cinch 34T

Chainguide

Rocky Mountain Spirit Guide

Bottom Bracket

Race Face BB92 30mm

Cassette

Shimano XTR 12s 10-51T

Chain

Shimano XTR 12s

F / Hub

Rocky Mountain Sealed Boost 15mm

R / Hub

DT Swiss 350 Boost 148mm

Spokes

DT Swiss Competition 2.0/1.8/2.0

F / Rim

Race Face ARC 30

R / Rim

Race Face ARC 30

F / Rim Tape

Tubeless Ready - Tape / Valves Incl.

R / Rim Tape

Tubeless Ready - Tape / Valves Incl.

F / Tire

Maxxis Minion DHR II WT Maxx Terra 3C
Tubeless Ready 27.5 x 2.4

R / Tire

Maxxis Minion DHR II WT Maxx Terra 3C
Tubeless Ready 27.5 x 2.4

Headset

FSA Orbit NO.57E

Stem

Rocky Mountain 35 CNC

Handlebar

Race Face Next R 780mm

Grips / Tape

Rocky Mountain Lock On XC

Seatpost

Race Face Turbine R (by Fox) Dropper 30.9mm

Saddle

WTB Volt Race 142

B0008

MSRP

Thunderbolt Carbon 70

MODEL HIGHLIGHTS

- The Thunderbolt strikes that perfect balance between quickness and surefootedness
- Mid Travel 140mm for quick, playful feel
- Full Carbon frame
- RIDE-9 Geometry adjustment tailors bike to suit the rider & terrain

IMPROVEMENTS OVER PREVIOUS MODEL

- Travel increased to 140mm front and rear
- Short offset fork for high speed stability
- New 12spd Shimano drivetrain
- Wider rims and tires for increased control

COLOUR 1



POISON
GLOSS

THE MAN IN BLACK
MATTE

BACK IN BLACK
GLOSS

COLOUR 2



SPACE ODDITY
GLOSS

THE MAN IN BLACK
MATTE

BACK IN BLACK
GLOSS

Front Triangle	Smoothwall Carbon. Full Sealed Cartridge Bearings. Press Fit BB. Internal Cable Routing. 2-Bolt ISCG05 Tabs. RIDE-9 Adjustable Geometry + Suspension Rate. 140mm Travel.
Chainstay	Smoothwall Carbon
Seatstay	Smoothwall Carbon
Fork	Fox 34 Float Performance Elite 140mm 37mm Offset
Rear Shock	Fox Float DPS EVOL Performance Elite
F / Brake	Shimano XT
R / Brake	Shimano XT
F / Rotor	Shimano RT66 180mm
R / Rotor	Shimano RT66 180mm
R / Shifter	Shimano XT
R / Derailleur	Shimano XT
Crankset	Race Face Aeffect Cinch 34T
Chainguide	Rocky Mountain Spirit Guide
Bottom Bracket	Shimano SM-BB71
Cassette	Shimano XT 10-51T
Chain	Shimano HG8100
F / Hub	Rocky Mountain Sealed Boost 15mm
R / Hub	DT Swiss 370 Boost 148mm
Spokes	DT Swiss Competition 2.0/1.8/2.0
F / Rim	Race Face ARC 30
R / Rim	Race Face ARC 30
F / Rim Tape	Tubeless Ready - Tape / Valves Incl.
R / Rim Tape	Tubeless Ready - Tape / Valves Incl.
F / Tire	Maxxis Minion DHR II WT Maxx Terra 3C Tubeless Ready 27.5 x 2.4
R / Tire	Maxxis Minion DHR II WT Maxx Terra 3C Tubeless Ready 27.5 x 2.4
Headset	FSA Orbit NO.57E
Stem	Rocky Mountain 35 AM
Handlebar	Race Face Turbine R 780mm
Grips / Tape	Rocky Mountain Lock On XC
Seatpost	Race Face Turbine R (by Fox) Dropper 30.9mm
Saddle	WTB Volt Race 142

B0009

MSRP

Thunderbolt Carbon 50

MODEL HIGHLIGHTS

- The Thunderbolt strikes that perfect balance between quickness and surefootedness
- Mid Travel 140mm for quick, playful feel
- Full Carbon frame
- RIDE-9 Geometry adjustment tailors bike to suit the rider & terrain

IMPROVEMENTS OVER PREVIOUS MODEL

- Travel increased to 140mm front and rear
- Short offset fork for high speed stability
- New 12spd Shimano drivetrain
- Wider rims and tires for increased control

COLOUR 1



POISON
GLOSS

THE MAN IN BLACK
MATTE

BACK IN BLACK
GLOSS

COLOUR 2



SPACE ODDITY
GLOSS

THE MAN IN BLACK
MATTE

BACK IN BLACK
GLOSS

Front Triangle

Smoothwall Carbon. Full Sealed Cartridge Bearings. Press Fit BB. Internal Cable Routing. 2-Bolt ISCG05 Tabs. RIDE-9 Adjustable Geometry + Suspension Rate. 140mm Travel.

Chainstay

Smoothwall Carbon

Seatstay

Smoothwall Carbon

Fork

Fox 34 Float Performance 140mm 37mm Offset

Rear Shock

Fox Float DPS EVOL Performance

F / Brake

Shimano SLX

R / Brake

Shimano SLX

F / Rotor

Shimano RT66 180mm

R / Rotor

Shimano RT66 180mm

R / Shifter

Shimano SLX

R / Derailleur

Shimano XT

Crankset

Race Face Aeffect Cinch 34T Steel

Chainguide

Rocky Mountain Spirit Guide

Bottom Bracket

Shimano SM-BBMT500

Cassette

Shimano SLX 10-51T

Chain

Shimano HG7100

F / Hub

Rocky Mountain Sealed Boost 15mm

R / Hub

DT Swiss 370 Boost 148mm

Spokes

DT Swiss Competition 2.0/1.8/2.0

F / Rim

WTB ST Light i30 TCS 2.0 Tubeless

R / Rim

WTB ST Light i30 TCS 2.0 Tubeless

F / Rim Tape

Tubeless Ready - Tape / Valves Incl.

R / Rim Tape

Tubeless Ready - Tape / Valves Incl.

F / Tire

Maxxis Minion DHR II WT EXO
Tubeless Ready 27.5 x 2.4

R / Tire

Maxxis Minion DHR II WT EXO
Tubeless Ready 27.5 x 2.4

Headset

FSA Orbit NO.57E

Stem

Rocky Mountain AM

Handlebar

Rocky Mountain AM 760mm

Grips / Tape

Rocky Mountain Lock On Light

Seatpost

Race Face Aeffect R Dropper 30.9mm

Saddle

WTB Volt Race 142

F0002

MSRP

Thunderbolt Carbon FRAMESET

MODEL HIGHLIGHTS

- 140mm Travel
- Mid travel for quick, playful feel
- Shockingly capable on rough trails
- Compatible with 26" x 2.8 wheels
- RIDE-9 Geometry adjustment tailors bike to suit the rider & terrain

COLOUR 1



POISON
GLOSS

THE MAN IN BLACK
MATTE

BACK IN BLACK
GLOSS

COLOUR 2



SPACE ODDITY
GLOSS

THE MAN IN BLACK
MATTE

BACK IN BLACK
GLOSS

Front Triangle

Smoothwall Carbon. Full Sealed Cartridge Bearings. Press Fit BB. Internal Cable Routing. 2-Bolt ISCG05 Tabs. RIDE-9 Adjustable Geometry + Suspension Rate. 140mm Travel.

Chainstay

Smoothwall Carbon

Seatstay

Smoothwall Carbon

Rear Shock

Fox Float DPS EVOL Factory

Chainguide

Rocky Mountain Spirit Guide

THUNDERBOLT ALLOY COLOURWAYS

Alloy 50 / 30 / 10

COLOUR 1

Thunderbolt Alloy 50 shown



POISON
GLOSS

THE MAN IN BLACK
GLOSS

Alloy 50 / 30 / 10

COLOUR 2

Thunderbolt Alloy 50 shown



SPACE ODDITY
MATTE

THE MAN IN BLACK
GLOSS

B0010

MSRP

Thunderbolt Alloy 50

MODEL HIGHLIGHTS

- The Thunderbolt strikes that perfect balance between quickness and surefootedness
- Mid Travel 140mm for quick, playful feel
- RIDE-9 Geometry adjustment tailors bike to suit the rider & terrain

IMPROVEMENTS OVER PREVIOUS MODEL

- Travel increased to 140mm front and rear
- Short offset fork for high speed stability
- New 12spd Shimano drivetrain
- Wider rims and tires for increased control

COLOUR 1



POISON
GLOSS

THE MAN IN BLACK
GLOSS

COLOUR 2



SPACE ODDITY
MATTE

THE MAN IN BLACK
GLOSS

Front Triangle

FORM Alloy. Full Sealed Cartridge Bearings. Press Fit BB. Internal Cable Routing. 2-Bolt ISCG05 Tabs. RIDE-9 Adjustable Geometry + Suspension Rate. 140mm Travel.

Chainstay

FORM Alloy

Seatstay

FORM Alloy

Fork

Fox 34 Float Performance 140mm 37mm Offset

Rear Shock

Fox Float DPS EVOL Performance

F / Brake

Shimano MT500

R / Brake

Shimano MT500

F / Rotor

Shimano RT66 180mm

R / Rotor

Shimano RT66 180mm

R / Shifter

Shimano SLX

R / Derailleur

Shimano XT

Crankset

Race Face Aeffect Cinch 34T Steel

Chainguide

Rocky Mountain Spirit Guide

Bottom Bracket

Shimano SM-BBMT500

Cassette

Shimano SLX 10-51T

Chain

Shimano HG7100

F / Hub

Rocky Mountain Sealed Boost 15mm

R / Hub

DT Swiss 370 Boost 148mm

Spokes

DT Swiss Competition 2.0/1.8/2.0

F / Rim

WTB ST Light i30 TCS 2.0 Tubeless

R / Rim

WTB ST Light i30 TCS 2.0 Tubeless

F / Rim Tape

Tubeless Ready - Tape / Valves Incl.

R / Rim Tape

Tubeless Ready - Tape / Valves Incl.

F / Tire

Maxxis Minion DHR II WT EXO
Tubeless Ready 27.5 x 2.4

R / Tire

Maxxis Minion DHR II WT EXO
Tubeless Ready 27.5 x 2.4

Headset

FSA Orbit NO.57E

Stem

Rocky Mountain AM

Handlebar

Rocky Mountain AM 760mm

Grips / Tape

Rocky Mountain Lock On Light

Seatpost

Race Face Aeffect R Dropper 30.9mm

Saddle

WTB Volt Race 142

B0011

MSRP

Thunderbolt Alloy 30

MODEL HIGHLIGHTS

- The Thunderbolt strikes that perfect balance between quickness and surefootedness
- Mid Travel 140mm for quick, playful feel
- RIDE-9 Geometry adjustment tailors bike to suit the rider & terrain

IMPROVEMENTS OVER PREVIOUS MODEL

- Travel increased to 140mm front and rear
- Short offset fork for high speed stability
- New 12spd Sram Eagle drivetrain
- Wider rims and tires for increased control
- Tubeless Ready
- Rocky Mountain Toonie Drop post

COLOUR 1



POISON
GLOSS

THE MAN IN BLACK
GLOSS

COLOUR 2



SPACE ODDITY
MATTE

THE MAN IN BLACK
GLOSS

Front Triangle

FORM Alloy. Full Sealed Cartridge Bearings. Press Fit BB. Internal Cable Routing. 2-Bolt ISCG05 Tabs. RIDE-9 Adjustable Geometry + Suspension Rate. 140mm Travel.

Chainstay

FORM Alloy

Seatstay

FORM Alloy

Fork

RockShox Sektor RL 140mm 37mm Offset

Rear Shock

RockShox Deluxe Select+ RT

F / Brake

Shimano MT400

R / Brake

Shimano MT400

F / Rotor

Shimano RT54 180mm

R / Rotor

Shimano RT54 180mm

R / Shifter

Sram SX Eagle

R / Derailleur

Sram SX Eagle

Crankset

Sram SX Eagle 34T

Chainguide

Rocky Mountain Spirit Guide

Bottom Bracket

Sram BB92 DUB

Cassette

Sram PG-1210 11-50T

Chain

Sram SX Eagle

F / Hub

Shimano MT400 Boost 15mm

R / Hub

Shimano MT400 Boost 148mm

Spokes

2.0 Stainless

F / Rim

WTB ST i30 TCS 2.0 Tubeless

R / Rim

WTB ST i30 TCS 2.0 Tubeless

F / Rim Tape

Tubeless Ready - Tape / Valves Incl.

R / Rim Tape

Tubeless Ready - Tape / Valves Incl.

F / Tire

Maxxis Minion DHR II WT EXO
Tubeless Ready 27.5 x 2.4

R / Tire

Maxxis Minion DHR II WT EXO
Tubeless Ready 27.5 x 2.4

Headset

FSA Orbit NO.57E

Stem

Rocky Mountain AM

Handlebar

Rocky Mountain AM 760mm

Grips / Tape

Rocky Mountain Lock On Light

Seatpost

Rocky Mountain Toonie Drop 30.9mm

Saddle

WTB Volt Race 142

B0012

MSRP

Thunderbolt Alloy 10

MODEL HIGHLIGHTS

- The most affordable dual suspension bike we offer
- The Thunderbolt strikes that perfect balance between quickness and surefootedness
- Mid Travel 140mm for quick, playful feel
- RIDE-9 Geometry adjustment tailors bike to suit the rider & terrain

IMPROVEMENTS OVER PREVIOUS MODEL

- Travel increased to 140mm front and rear
- Boost 148mm Thru Axle rear hub
- Short offset fork for high speed stability
- Wider rims and tires for increased control
- Rocky Mountain Toonie Drop post

COLOUR 1



POISON
GLOSS

THE MAN IN BLACK
GLOSS

COLOUR 2



SPACE ODDITY
MATTE

THE MAN IN BLACK
GLOSS

Front Triangle	FORM Alloy. Full Sealed Cartridge Bearings. Press Fit BB. Internal Cable Routing. 2-Bolt ISCG05 Tabs. RIDE-9 Adjustable Geometry + Suspension Rate. 140mm Travel.
Chainstay	FORM Alloy
Seatstay	FORM Alloy
Fork	RockShox Recon RL 140mm 37mm Offset
Rear Shock	RockShox Deluxe Select+ RT
F / Brake	Shimano MT200
R / Brake	Shimano MT200
F / Rotor	Shimano RT30 180mm
R / Rotor	Shimano RT30 180mm
R / Shifter	Shimano Deore
R / Derailleur	Shimano Deore
Crankset	Rocky Mountain Microdrive 2 PC 32T
Chainguide	Rocky Mountain Spirit Guide
Cassette	SunRace CSMS2 11-46T
Chain	KMC X10-1
F / Hub	Shimano MT400 Boost 15mm
R / Hub	Shimano MT400 Boost 148mm
Spokes	2.0 Stainless
F / Rim	WTB ST i25 TCS Tubeless
R / Rim	WTB ST i25 TCS Tubeless
F / Tire	WTB Trail Boss Comp 27.5 x 2.25
R / Tire	WTB Trail Boss Comp 27.5 x 2.25
Headset	FSA Orbit NO.57E
Stem	Rocky Mountain AM
Handlebar	Rocky Mountain AM 760mm
Grips / Tape	Rocky Mountain Lock On Light
Seatpost	Rocky Mountain Toonie Drop 30.9mm
Saddle	WTB Volt 142

INSTINCT

DESIGNED FOR
Trail

FRONT TRAVEL
140 MM





REAR TRAVEL
140 MM

WHEEL SIZE
29" (27.5+ ready)

Trust your Instinct. Stable and aggressive, the Instinct is our most versatile trail bike.

Whether you're setting out on an all-day epic or pushing the limits of what's possible on your local trails, the Instinct's ride-quality is second to none. Available in both carbon and alloy, the combination of fast rolling 29" wheels, modern trail geometry, and our RIDE-9 adjustment system means the Instinct is ready for anything you throw at it.

FRAME TECHNOLOGY

-  **Smoothwall Carbon**
FRAME MATERIAL
-  **FORM Alloy**
FRAME MATERIAL
-  **RIDE-9**
ADJUSTMENT SYSTEM
-  **Smoothlink**
SUSPENSION
-  **Size Specific**
TUNE

NOTES

Rider:
Peter Ostroski

Photo:
Brooks Curran

Location:
Northeastern USA



INSTINCT CARBON & ALLOY

GEOMETRY

Geometry shown for Slack, Neutral, and Steep RIDE-9™ positions.

- HTA** Head Tube Angle (deg)
- STA** Seat Tube Angle (deg)
- STL** Seat Tube Length (mm)
- TTH** Top Tube Horizontal (mm)
- HTL** Head Tube Length (mm)
- RC** Rear Centre (mm)
- BBD** Bottom Bracket Drop (mm)
- SH** Standover Height (mm)
- WB** Wheelbase (mm)
- R** Reach (mm)
- S** Stack (mm)

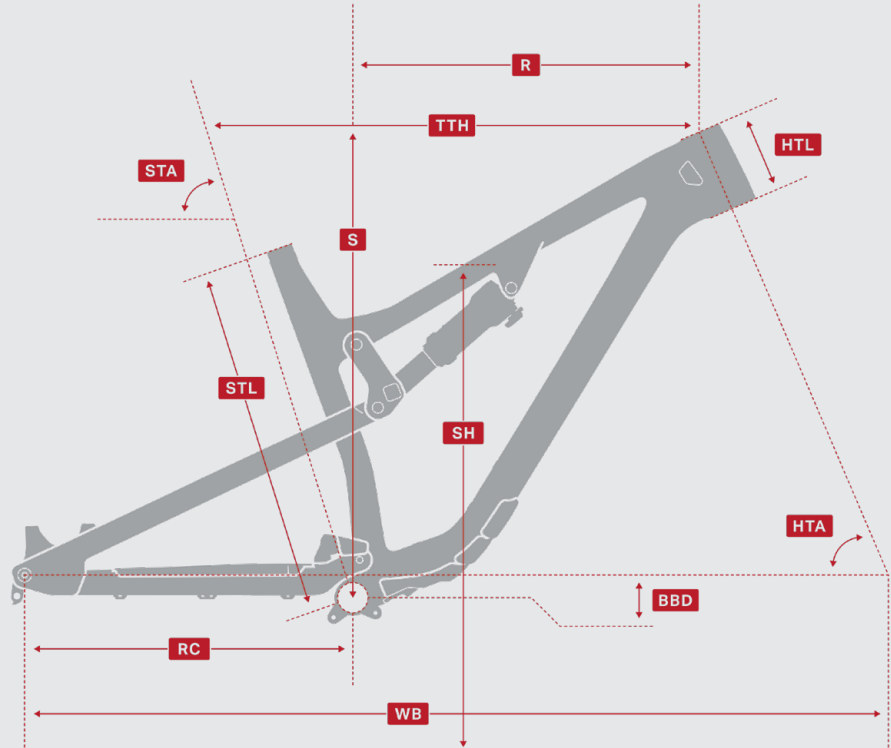

	SM			MD			LG			XL		
	Slack	Neutral	Steep	Slack	Neutral	Steep	Slack	Neutral	Steep	Slack	Neutral	Steep
HTA	66°	66.5°	67°	66°	66.5°	67°	66°	66.5°	67°	66°	66.5°	67°
STA	74.5°	75°	75.5°	74.5°	75°	75.5°	74.5°	75°	75.5°	74.5°	75°	75.5°
STL	392	392	392	432	432	432	470	470	470	508	508	508
TTH	576	575	574	601	600	599	626	625	624	656	655	654
HTL	95	95	95	100	100	100	110	110	110	120	120	120
RC	436	435	434	436	435	434	436	435	434	436	435	434
BBD	36	30	23	36	30	23	37	30	23	37	30	23
SH	816	818	820	811	814	816	810	813	815	809	812	815
WB	1154	1154	1153	1179	1179	1178	1206	1206	1205	1237	1237	1236
R	408	413	419	432	437	443	455	460	465	482	487	493
S	607	603	599	611	608	604	621	617	613	630	626	622

INSTINCT CARBON COLOURWAYS

Carbon 90 / 70 / 50

COLOUR 1

Instinct Carbon 90 shown



ZOMBIE
GLOSS

SUNDAY BLOODY SUNDAY
GLOSS

VOLCANO
GLOSS

Carbon 90 / 70 / 50

COLOUR 2

Instinct Carbon 90 shown



DEEP DARK WOODS
GLOSS

UD CARBON
MATTE

BILLY OCEAN
GLOSS

INSTINCT CARBON COLOURWAYS

Carbon Frameset

COLOUR 1



ZOMBIE
GLOSS

SUNDAY BLOODY SUNDAY
GLOSS

VOLCANO
GLOSS

Carbon Frameset

COLOUR 2



DEEP DARK WOODS
GLOSS

UD CARBON
MATTE

BILLY OCEAN
GLOSS

B0013

MSRP

Instinct Carbon 90

MODEL HIGHLIGHTS

- New high end spec in our best selling Instinct range
- The Instinct is Rocky Mountain's most versatile platform
- Mid travel for quick, playful feel, yet has 29" stability & confidence
- Compatible up to 29" x 2.6 / 27.5" x 2.8
- RIDE-9 Geometry adjustment tailors bike to suit the rider & terrain

COLOUR 1



ZOMBIE
GLOSS

SUNDAY BLOODY SUNDAY
GLOSS

VOLCANO
GLOSS

COLOUR 2



DEEP DARK WOODS
GLOSS

UD CARBON
MATTE

BILLY OCEAN
GLOSS

Front Triangle	Smoothwall Carbon. Full Sealed Cartridge Bearings. Press Fit BB. Internal Cable Routing. RIDE-9 Adjustable Geometry + Suspension Rate. 140mm Travel.
Chainstay	Smoothwall Carbon
Seatstay	Smoothwall Carbon
Fork	Fox 36 Float EVOL FIT4 Factory Series 140mm 44mm Offset
Rear Shock	Fox Float DPS EVOL Factory
F / Brake	Shimano XTR Trail 4 Piston
R / Brake	Shimano XTR Trail 4 Piston
F / Rotor	Shimano RT86 180mm
R / Rotor	Shimano RT86 180mm
R / Shifter	Shimano XTR
R / Derailleur	Shimano XTR
Crankset	Race Face Next R Cinch 32T
Chainguide	Rocky Mountain Spirit Guide
Bottom Bracket	Race Face BB92 30mm
Cassette	Shimano XTR 12s 10-51T
Chain	Shimano XTR 12s
F / Hub	Rocky Mountain Sealed Boost 15mm
R / Hub	DT Swiss 350 Boost 148mm
Spokes	DT Swiss Competition 2.0/1.8/2.0
F / Rim	Race Face ARC 30
R / Rim	Race Face ARC 30
F / Rim Tape	Tubeless Ready - Tape / Valves Incl.
R / Rim Tape	Tubeless Ready - Tape / Valves Incl.
F / Tire	Maxxis Minion DHR II WT Maxx Terra 3C Tubeless Ready 29 x 2.4
R / Tire	Maxxis Minion DHR II WT Maxx Terra 3C Tubeless Ready 29 x 2.4
Headset	FSA Orbit NO.57E
Stem	Rocky Mountain 35 CNC
Handlebar	Race Face Next R 780mm
Grips / Tape	Rocky Mountain Lock On XC
Seatpost	Race Face Turbine R (by Fox) Dropper 30.9mm
Saddle	WTB Volt Race 142

B0014

MSRP

Instinct Carbon 70

MODEL HIGHLIGHTS

- The Instinct is Rocky Mountain's most versatile platform
- Mid travel for quick, playful feel, yet has 29" stability & confidence
- Smart spec leaves nothing to upgrade
- RIDE-9 Geometry adjustment tailors bike to suit the rider & terrain

IMPROVEMENTS OVER PREVIOUS MODEL

- Fox 36 fork
- Short offset fork for high speed stability
- New 12spd Shimano drivetrain
- Wider rims and tires for increased control

COLOUR 1



ZOMBIE
GLOSS

SUNDAY BLOODY SUNDAY
GLOSS

VOLCANO
GLOSS

COLOUR 2



DEEP DARK WOODS
GLOSS

UD CARBON
MATTE

BILLY OCEAN
GLOSS

Front Triangle

Smoothwall Carbon. Full Sealed Cartridge Bearings. Press Fit BB. Internal Cable Routing. RIDE-9 Adjustable Geometry + Suspension Rate. 140mm Travel.

Chainstay

Smoothwall Carbon

Seatstay

Smoothwall Carbon

Fork

Fox 36 Float EVOL FIT4 Performance Elite Series 140mm 44mm Offset

Rear Shock

Fox Float DPS EVOL Performance Elite

F / Brake

Shimano XT

R / Brake

Shimano XT

F / Rotor

Shimano RT66 180mm

R / Rotor

Shimano RT66 180mm

R / Shifter

Shimano XT

R / Derailleur

Shimano XT

Crankset

Race Face Aeffect Cinch 32T

Chainguide

Rocky Mountain Spirit Guide

Bottom Bracket

Shimano SM-BB71

Cassette

Shimano XT 10-51T

Chain

Shimano HG8100

F / Hub

Rocky Mountain Sealed Boost 15mm

R / Hub

DT Swiss 370 Boost 148mm

Spokes

DT Swiss Competition 2.0/1.8/2.0

F / Rim

Race Face AR 30

R / Rim

Race Face AR 30

F / Rim Tape

Tubeless Ready - Tape / Valves Incl.

R / Rim Tape

Tubeless Ready - Tape / Valves Incl.

F / Tire

Maxxis Minion DHR II WT Maxx Terra 3C Tubeless Ready 29 x 2.4

R / Tire

Maxxis Minion DHR II WT Maxx Terra 3C Tubeless Ready 29 x 2.4

Headset

FSA Orbit NO.57E

Stem

Rocky Mountain 35 AM

Handlebar

Race Face Turbine R 780mm

Grips / Tape

Rocky Mountain Lock On XC

Seatpost

Race Face Turbine R (by Fox) Dropper 30.9mm

Saddle

WTB Volt Race 142

B0015

MSRP

Instinct Carbon 50

MODEL HIGHLIGHTS

- The Instinct is Rocky Mountain's most versatile platform
- Mid travel for quick, playful feel, yet has 29" stability & confidence
- Smart spec leaves nothing to upgrade
- RIDE-9 Geometry adjustment tailors bike to suit the rider & terrain

IMPROVEMENTS OVER PREVIOUS MODEL

- Fox 36 fork
- Short offset fork for high speed stability
- New 12spd Shimano drivetrain
- Wider rims and tires for increased control
- OneUp Dropper Post

COLOUR 1



ZOMBIE
GLOSS

SUNDAY BLOODY SUNDAY
GLOSS

VOLCANO
GLOSS

COLOUR 2



DEEP DARK WOODS
GLOSS

UD CARBON
MATTE

BILLY OCEAN
GLOSS

Front Triangle	Smoothwall Carbon. Full Sealed Cartridge Bearings. Press Fit BB. Internal Cable Routing. RIDE-9 Adjustable Geometry + Suspension Rate. 140mm Travel.
Chainstay	FORM Alloy
Seatstay	FORM Alloy
Fork	Fox 36 Float EVOL GRIP Performance Series 140mm 44mm Offset
Rear Shock	Fox Float DPS EVOL Performance
F / Brake	Shimano SLX
R / Brake	Shimano SLX
F / Rotor	Shimano RT66 180mm
R / Rotor	Shimano RT66 180mm
R / Shifter	Shimano SLX
R / Derailleur	Shimano XT
Crankset	Race Face Aeffect Cinch 32T Steel
Chainguide	Rocky Mountain Spirit Guide
Bottom Bracket	Shimano SM-BBMT500
Cassette	Shimano SLX 10-51T
Chain	Shimano HG7100
F / Hub	Rocky Mountain Sealed Boost 15mm
R / Hub	DT Swiss 370 Boost 148mm
Spokes	DT Swiss Competition 2.0/1.8/2.0
F / Rim	WTB ST Light i30 TCS 2.0 Tubeless
R / Rim	WTB ST Light i30 TCS 2.0 Tubeless
F / Rim Tape	Tubeless Ready - Tape / Valves Incl.
R / Rim Tape	Tubeless Ready - Tape / Valves Incl.
F / Tire	Maxxis Minion DHR II WT EXO Tubeless Ready 29 x 2.4
R / Tire	Maxxis Minion DHR II WT EXO Tubeless Ready 29 x 2.4
Headset	FSA Orbit NO.57E
Stem	Rocky Mountain AM
Handlebar	Rocky Mountain AM 760mm
Grips / Tape	Rocky Mountain Lock On Light
Seatpost	OneUp Dropper Post 30.9mm
Saddle	WTB Volt Race 142

F0004

MSRP

Instinct Carbon FRAMESET

MODEL HIGHLIGHTS

- 140mm Travel
- The most versatile Rocky Mountain platform
- Full carbon frame
- Compatible with 27.5" x 2.8

COLOUR 1



ZOMBIE
GLOSS

SUNDAY BLOODY SUNDAY
GLOSS

VOLCANO
GLOSS

COLOUR 2



DEEP DARK WOODS
GLOSS

UD CARBON
MATTE

BILLY OCEAN
GLOSS

Front Triangle

Smoothwall Carbon. Full Sealed Cartridge Bearings. Press Fit BB. Internal Cable Routing. RIDE-9 Adjustable Geometry + Suspension Rate. 140mm Travel.

Chainstay

Smoothwall Carbon

Seatstay

Smoothwall Carbon

Rear Shock

Fox Float DPS EVOL Factory

Chainguide

Rocky Mountain Spirit Guide

INSTINCT ALLOY COLOURWAYS

Alloy 50 / 30

COLOUR 1

Instinct Alloy 50 shown



ZOMBIE
GLOSS

THE MAN IN BLACK
GLOSS

VOLCANO
GLOSS

Alloy 50 / 30

COLOUR 2

Instinct Alloy 50 shown



DEEP DARK WOODS
GLOSS

THE MAN IN BLACK
GLOSS

BILLY OCEAN
GLOSS

B0016

MSRP

Instinct Alloy 50

MODEL HIGHLIGHTS

- The Instinct is Rocky Mountain's most versatile platform
- Mid travel for quick, playful feel, yet has 29" stability & confidence
- Reliable Shimano XT shifting & braking
- RIDE-9 Geometry adjustment tailors bike to suit the rider & terrain

IMPROVEMENTS OVER PREVIOUS MODEL

- RockShox Pike (44mm offset) with Charger RC damper
- Shimano XT brakes
- New 12spd Shimano drivetrain
- Tubeless ready

COLOUR 1



ZOMBIE
GLOSS

THE MAN IN BLACK
GLOSS

VOLCANO
GLOSS

COLOUR 2



DEEP DARK WOODS
GLOSS

THE MAN IN BLACK
GLOSS

BILLY OCEAN
GLOSS

Front Triangle

FORM Alloy. Full Sealed Cartridge Bearings. Press Fit BB. Internal Cable Routing. 2-Bolt ISCG05 Tabs. RIDE-9 Adjustable Geometry + Suspension Rate. 140mm Travel.

Chainstay

FORM Alloy

Seatstay

FORM Alloy

Fork

RockShox Pike Select RC 140mm 42mm Offset

Rear Shock

RockShox Deluxe Select+ RT

F / Brake

Shimano XT

R / Brake

Shimano XT

F / Rotor

Shimano RT66 180mm

R / Rotor

Shimano RT66 180mm

R / Shifter

Shimano XT

R / Derailleur

Shimano XT

Crankset

Race Face Ride Cinch 32T Steel

Chainguide

Rocky Mountain Spirit Guide

Bottom Bracket

Shimano SM-BBMT500

Cassette

Shimano XT 10-51T

Chain

Shimano HG8100

F / Hub

Rocky Mountain Sealed Boost 15mm Torque Cap

R / Hub

DT Swiss 370 Boost 148mm

Spokes

DT Swiss Competition 2.0/1.8/2.0

F / Rim

WTB ST Light i30 TCS 2.0 Tubeless

R / Rim

WTB ST Light i30 TCS 2.0 Tubeless

F / Rim Tape

Tubeless Ready - Tape / Valves Incl.

R / Rim Tape

Tubeless Ready - Tape / Valves Incl.

F / Tire

Maxxis Minion DHR II WT EXO
Tubeless Ready 29 x 2.4

R / Tire

Maxxis Minion DHR II WT EXO
Tubeless Ready 29 x 2.4

Headset

FSA Orbit NO.57E

Stem

Rocky Mountain AM

Handlebar

Rocky Mountain AM 760mm

Grips / Tape

Rocky Mountain Lock On Light

Seatpost

Race Face Aeffect R Dropper 30.9mm

Saddle

WTB Volt Race 142

B0017

MSRP

Instinct Alloy 30

MODEL HIGHLIGHTS

- New entry level spec in our best selling Instinct range
- Mid travel for quick, playful feel, yet has 29" stability & confidence
- Sram SX Eagle drivetrain
- RIDE-9 Geometry adjustment tailors bike to suit the rider & terrain

COLOUR 1



ZOMBIE
GLOSS

THE MAN IN BLACK
GLOSS

VOLCANO
GLOSS

COLOUR 2



DEEP DARK WOODS
GLOSS

THE MAN IN BLACK
GLOSS

BILLY OCEAN
GLOSS

Front Triangle

FORM Alloy. Full Sealed Cartridge Bearings. Press Fit BB. Internal Cable Routing. 2-Bolt ISCG05 Tabs. RIDE-9 Adjustable Geometry + Suspension Rate. 140mm Travel.

Chainstay

FORM Alloy

Seatstay

FORM Alloy

Fork

RockShox 35 Gold RL 140mm 44mm Offset

Rear Shock

RockShox Deluxe Select+ RT

F / Brake

Shimano MT400

R / Brake

Shimano MT400

F / Rotor

Shimano RT54 180mm

R / Rotor

Shimano RT54 180mm

R / Shifter

Sram SX Eagle

R / Derailleur

Sram SX Eagle

Crankset

Sram SX Eagle 32T

Chainguide

Rocky Mountain Spirit Guide

Bottom Bracket

Sram BB92 DUB

Cassette

Sram PG-1210 11-50T

Chain

Sram SX Eagle

F / Hub

Shimano MT400 Boost 15mm

R / Hub

Shimano MT400 Boost 148mm

Spokes

2.0 Stainless

F / Rim

WTB ST Light i30 TCS 2.0 Tubeless

R / Rim

WTB ST Light i30 TCS 2.0 Tubeless

F / Rim Tape

Tubeless Ready - Tape / Valves Incl.

R / Rim Tape

Tubeless Ready - Tape / Valves Incl.

F / Tire

Maxxis Minion DHR II WT EXO
Tubeless Ready 29 x 2.4

R / Tire

Maxxis Minion DHR II WT EXO
Tubeless Ready 29 x 2.4

Headset

FSA Orbit NO.57E

Stem

Rocky Mountain AM

Handlebar

Rocky Mountain AM 760mm

Grips / Tape

Rocky Mountain Lock On Light

Seatpost

Rocky Mountain Toonie Drop 30.9mm

Saddle

WTB Volt 142



INSTINCT CARBON & ALLOY BC EDITION

DESIGNED FOR

Enduro

WHEEL SIZE

29" (27.5+ ready)

FRONT TRAVEL

160 mm

REAR TRAVEL

155 mm

Born in BC, we've turned the Instinct into an aggressive trail monster.

Designed with an optimized single-position link, ultra-aggressive geometry, and a long stroke shock that provides 155mm of rear travel, we've kitted out the Instinct BC with wide bars, big tires, ultra-stiff wheels, and more capable suspension. It smashes all mountain lines, rails corners, and plows over everything in sight, while displaying all the climbing efficiency that makes the Instinct a crowd favourite.

GEOMETRY

- HTA** Head Tube Angle (deg)
- STA** Seat Tube Angle (deg)
- STL** Seat Tube Length (mm)
- TTH** Top Tube Horizontal (mm)
- HTL** Head Tube Length (mm)
- RC** Rear Centre (mm)
- BBD** Bottom Bracket Drop (mm)
- SH** Standover Height (mm)
- WB** Wheelbase (mm)
- R** Reach (mm)
- S** Stack (mm)

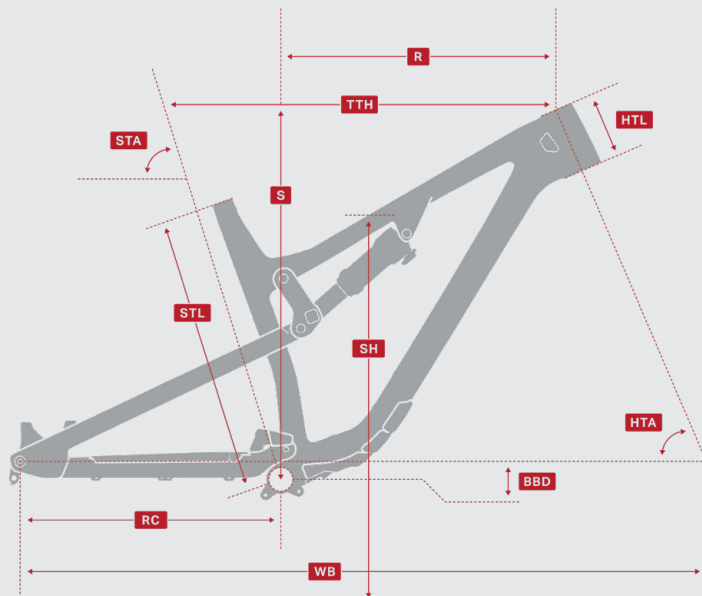

	SM	MD	LG	XL
HTA	65.9°	65.9°	65.9°	65.9°
STA	74.4°	74.4°	74.4°	74.4°
STL	392	432	470	508
TTH	577	602	627	657
HTL	95	100	110	120
RC	435	435	435	435
BBD	19	19	19	19
SH	834	829	828	827
WB	1161	1187	1213	1245
R	407	431	454	481
S	607	612	621	630

INSTINCT CARBON COLOURWAYS

Carbon 90 BC Edition / 70 BC Edition

COLOUR 1

Instinct Carbon 90 BC Edition shown



Carbon 90 BC Edition / 70 BC Edition

COLOUR 2

Instinct Carbon 90 BC Edition shown



INSTINCT CARBON COLOURWAYS

Carbon BC Edition Frameset

COLOUR 1



THE MAN IN BLACK
MATTE

NEVERMIND
MATTE

BRASS MONKEY
GLOSS

Carbon BC Edition Frameset

COLOUR 2



THE MAN IN BLACK
GLOSS

RUSTY CAGE
GLOSS

YELLOW SUBMARINE
GLOSS

B0019

MSRP

Instinct Carbon 90 BC EDITION

MODEL HIGHLIGHTS

- New high end spec
- Designed to handle the aggressive trails on Vancouver's North Shore, our BC Edition bikes are ready for whatever you throw at them
- Spec focused on suspension and braking, where it counts
- Long travel 29'er with trail bike manners: can plow AND still maneuver

IMPROVEMENTS OVER PREVIOUS MODEL

- Upgraded across the board!

COLOUR 1



THE MAN IN BLACK
MATTE

NEVERMIND
MATTE

BRASS MONKEY
GLOSS

COLOUR 2



THE MAN IN BLACK
GLOSS

RUSTY CAGE
GLOSS

YELLOW SUBMARINE
GLOSS

Front Triangle	Smoothwall Carbon. Full Sealed Cartridge Bearings. Press Fit BB. Internal Cable Routing. 155mm Travel.
Chainstay	Smoothwall Carbon
Seatstay	Smoothwall Carbon
Fork	Fox 36 Float EVOL GRIP2 Factory 160mm 44mm Offset
Rear Shock	Fox Float DPX2 EVOL Factory
F / Brake	Sram Code RSC
R / Brake	Sram Code RSC
F / Rotor	Sram Centerline 200mm
R / Rotor	Sram Centerline 200mm
R / Shifter	Sram X01 Eagle
R / Derailleur	Sram X01 Eagle
Crankset	Sram X1 Carbon Eagle 32T
Chainguide	Rocky Mountain Spirit Guide
Bottom Bracket	Sram BB92 DUB
Cassette	Sram XG-1295 10-50T
Chain	Sram X01 Eagle
F / Hub	Rocky Mountain Sealed Boost 15mm
R / Hub	DT Swiss 350 Boost 148mm
Spokes	DT Swiss Competition 2.0/1.8/2.0
F / Rim	Race Face ARC 30
R / Rim	Race Face ARC 30
F / Rim Tape	Tubeless Ready - Tape / Valves Incl.
R / Rim Tape	Tubeless Ready - Tape / Valves Incl.
F / Tire	Maxxis Minion DHF WT Maxx Terra 3C Tubeless Ready 29 x 2.5
R / Tire	Maxxis Aggressor WT EXO Tubeless Ready 29 x 2.5
Headset	FSA Orbit NO.57E
Stem	Rocky Mountain 35 CNC
Handlebar	Race Face Next R 780mm
Grips / Tape	Rocky Mountain Lock On XC
Seatpost	Race Face Turbine R (by Fox) Dropper 30.9mm
Saddle	WTB Volt Race 142

B0020

MSRP

Instinct Carbon 70 BC EDITION

MODEL HIGHLIGHTS

- Replaces Instinct Carbon 90 BC Edition from 2019
- Designed to handle the aggressive trails on Vancouver's North Shore, our BC Edition bikes are ready for whatever you throw at them
- Spec focused on suspension and braking, where it counts
- Long travel 29'er with trail bike manners: can plow AND still maneuver

IMPROVEMENTS OVER PREVIOUS MODEL

- Short offset fork for high speed stability
- Shimano XT 4 piston brakes
- New Shimano 12spd drivetrain

COLOUR 1



THE MAN IN BLACK
MATTE

NEVERMIND
MATTE

BRASS MONKEY
GLOSS

COLOUR 2



THE MAN IN BLACK
GLOSS

RUSTY CAGE
GLOSS

YELLOW SUBMARINE
GLOSS

Front Triangle

Smoothwall Carbon. Full Sealed Cartridge Bearings. Press Fit BB. Internal Cable Routing. 155mm Travel.

Chainstay

Smoothwall Carbon

Seatstay

Smoothwall Carbon

Fork

Fox 36 Float EVOL GRIP2 Performance Elite 160mm 44mm Offset

Rear Shock

Fox Float DPX2 Performance

F / Brake

Shimano XT Trail 4 Piston

R / Brake

Shimano XT Trail 4 Piston

F / Rotor

Shimano RT66 203mm

R / Rotor

Shimano RT66 203mm

R / Shifter

Shimano XT

R / Derailleur

Shimano XT

Crankset

Race Face Turbine Cinch 32T

Chainguide

Rocky Mountain Spirit Guide

Bottom Bracket

Race Face BB92 30mm

Cassette

Shimano XT 10-51T

Chain

Shimano HG8100

F / Hub

Rocky Mountain Sealed Boost 15mm

R / Hub

DT Swiss 370 Boost 148mm

Spokes

DT Swiss Competition 2.0/1.8/2.0

F / Rim

Race Face AR 30

R / Rim

Race Face AR 30

F / Rim Tape

Tubeless Ready - Tape / Valves Incl.

R / Rim Tape

Tubeless Ready - Tape / Valves Incl.

F / Tire

Maxxis Minion DHF WT Maxx Terra 3C Tubeless Ready 29 x 2.5

R / Tire

Maxxis Aggressor WT EXO Tubeless Ready 29 x 2.5

Headset

FSA Orbit NO.57E

Stem

Rocky Mountain 35 AM

Handlebar

Race Face Turbine R 780mm

Grips / Tape

Rocky Mountain Lock On XC

Seatpost

Race Face Turbine R (by Fox) Dropper 30.9mm

Saddle

WTB Volt Race 142

F0003

MSRP

Instinct Carbon BC EDITION FRAMESET

MODEL HIGHLIGHTS

- 155mm Travel
- Long travel 29'er with trail bike manners: can plow AND still maneuver
- Full carbon frame
- Compatible with 27.5" x 2.8

COLOUR 1



THE MAN IN BLACK
MATTE

NEVERMIND
MATTE

BRASS MONKEY
GLOSS

COLOUR 2



THE MAN IN BLACK
GLOSS

RUSTY CAGE
GLOSS

YELLOW SUBMARINE
GLOSS

Front Triangle

Smoothwall Carbon. Full Sealed Cartridge Bearings. Press Fit BB. Internal Cable Routing. 155mm Travel.

Chainstay

Smoothwall Carbon

Seatstay

Smoothwall Carbon

Rear Shock

Fox Float DPX2 EVOL Factory

Chainguide

Rocky Mountain Spirit Guide

INSTINCT ALLOY COLOURWAYS

Alloy 70 BC Edition / 50 BC Edition

COLOUR 1

Instinct Alloy 70 BC Edition shown



NEVERMIND
MATTE

THE MAN IN BLACK
MATTE

BRASS MONKEY
GLOSS

Alloy 50 BC Edition

COLOUR 2



RUSTY CAGE
GLOSS

THE MAN IN BLACK
GLOSS

YELLOW SUBMARINE
GLOSS

B0021

MSRP

Instinct Alloy 70 BC EDITION

MODEL HIGHLIGHTS

- New high end alloy spec in our Instinct BC Edition range
- Designed to handle the aggressive trails on Vancouver's North Shore, our BC Edition bikes are ready for whatever you throw at them
- Fox Factory grade suspension
- Long travel 29'er with trail bike manners: can plow AND still maneuver

COLOUR 1



NEVERMIND
MATTE

THE MAN IN BLACK
MATTE

BRASS MONKEY
GLOSS

Front Triangle	FORM Alloy. Full Sealed Cartridge Bearings. Press Fit BB. Internal Cable Routing. 2-Bolt ISCG05 Tabs. 155mm Travel.
Chainstay	FORM Alloy
Seatstay	FORM Alloy
Fork	Fox 36 Float EVOL GRIP2 Factory 160mm 44mm Offset
Rear Shock	Fox Float DPX2 EVOL Factory
F / Brake	Shimano XT Trail 4 Piston
R / Brake	Shimano XT Trail 4 Piston
F / Rotor	Shimano RT66 203mm
R / Rotor	Shimano RT66 203mm
R / Shifter	Shimano XT
R / Derailleur	Shimano XT
Crankset	Race Face Aeffect Cinch 32T Steel
Chainguide	Rocky Mountain Spirit Guide
Bottom Bracket	Shimano SM-BBMT500
Cassette	Shimano XT 10-51T
Chain	Shimano HG7100
F / Hub	Rocky Mountain Sealed Boost 15mm
R / Hub	DT Swiss 370 Boost 148mm
Spokes	DT Swiss Competition 2.0/1.8/2.0
F / Rim	Race Face AR 30
R / Rim	Race Face AR 30
F / Rim Tape	Tubeless Ready - Tape / Valves Incl.
R / Rim Tape	Tubeless Ready - Tape / Valves Incl.
F / Tire	Maxxis Minion DHF WT Maxx Terra 3C Tubeless Ready 29 x 2.5
R / Tire	Maxxis Aggressor WT EXO Tubeless Ready 29 x 2.5
Headset	FSA Orbit NO.57E
Stem	Rocky Mountain 35 AM
Handlebar	Rocky Mountain AM 780mm
Grips / Tape	Rocky Mountain Lock On Light
Seatpost	OneUp Dropper Post 30.9mm
Saddle	WTB Volt Race 142

B0022

MSRP

Instinct Alloy 50 BC EDITION

MODEL HIGHLIGHTS

- Designed to handle the aggressive trails on Vancouver's North Shore, our BC Edition bikes are ready for whatever you throw at them
- Spec focused on suspension and braking, where it counts
- Long travel 29'er with trail bike manners: can plow AND still maneuver

IMPROVEMENTS OVER PREVIOUS MODEL

- Short offset fork for high speed stability
- 2nd colour choice
- Wider saddle for comfort

COLOUR 1



NEVERMIND
MATTE

THE MAN IN BLACK
MATTE

BRASS MONKEY
GLOSS

COLOUR 2



RUSTY CAGE
GLOSS

THE MAN IN BLACK
GLOSS

YELLOW SUBMARINE
GLOSS

Front Triangle	FORM Alloy. Full Sealed Cartridge Bearings. Press Fit BB. Internal Cable Routing. 2-Bolt ISCG05 Tabs. 155mm Travel.
Chainstay	FORM Alloy
Seatstay	FORM Alloy
Fork	Fox 36 Float Grip Performance 160mm 44mm Offset
Rear Shock	Fox Float DPX2 Performance
F / Brake	Sram Guide RE
R / Brake	Sram Guide RE
F / Rotor	Sram Centerline 200mm
R / Rotor	Sram Centerline 200mm
R / Shifter	Sram GX Eagle
R / Derailleur	Sram GX Eagle
Crankset	Sram Descendent 6k Eagle 32T
Chainguide	Rocky Mountain Spirit Guide
Bottom Bracket	Sram BB92 DUB
Cassette	Sram PG-1230 11-50T
Chain	Sram NX Eagle
F / Hub	Rocky Mountain Sealed Boost 15mm
R / Hub	DT Swiss 370 Boost 148mm
Spokes	DT Swiss Competition 2.0/1.8/2.0
F / Rim	Race Face AR 30
R / Rim	Race Face AR 30
F / Rim Tape	Tubeless Ready - Tape / Valves Incl.
R / Rim Tape	Tubeless Ready - Tape / Valves Incl.
F / Tire	Maxxis Minion DHF WT EXO Tubeless Ready 29 x 2.5
R / Tire	Maxxis Aggressor WT EXO Tubeless Ready 29 x 2.5
Headset	FSA Orbit NO.57E
Stem	Rocky Mountain 35 AM
Handlebar	Rocky Mountain AM 780mm
Grips / Tape	Rocky Mountain Lock On Light
Seatpost	Race Face Turbine R (by Fox) Dropper 30.9mm
Saddle	WTB Volt Race 142

ALTITUDE

DESIGNED FOR
Enduro

FRONT TRAVEL
160 MM

REAR TRAVEL
150 MM

WHEEL SIZE
27.5 Wide Trail

NOTES

Taking trail to new heights. Often imitated but never surpassed, the Altitude pushes the envelope of what a modern trail bike is capable of.

The Altitude is our highly capable, fun, do-it-all trail bike. It's the perfect blend of pedaling efficiency, small-bump sensitivity, and has the ability to charge hard! The Altitude is easy to get along with, tackles whatever you throw at it, and helps boost confidence when looking to navigate a technical section of trail. Available in both carbon and alloy models, the frame integrates next-generation features like Fox Live and Shimano Di2 compatibility, while giving the rider the opportunity to tailor the bike to their riding style and terrain using our RIDE-9 adjustment system.

FRAME TECHNOLOGY



Smoothwall Carbon
FRAME MATERIAL



FORM Alloy
FRAME MATERIAL



Smoothlink
SUSPENSION



RIDE-9
ADJUSTMENT SYSTEM



Size Specific
TUNE

Rider:
Thomas Vanderham

Photo:
Margus Riga

Location:
France



ALTITUDE CARBON & ALLOY

GEOMETRY

Geometry shown for Slack, Neutral, and Steep RIDE-9™ positions.

- HTA** Head Tube Angle (deg)
- STA** Seat Tube Angle (deg)
- STL** Seat Tube Length (mm)
- TTH** Top Tube Horizontal (mm)
- HTL** Head Tube Length (mm)
- RC** Rear Centre (mm)
- BBD** Bottom Bracket Drop (mm)
- SH** Standover Height (mm)
- WB** Wheelbase (mm)
- R** Reach (mm)
- S** Stack (mm)

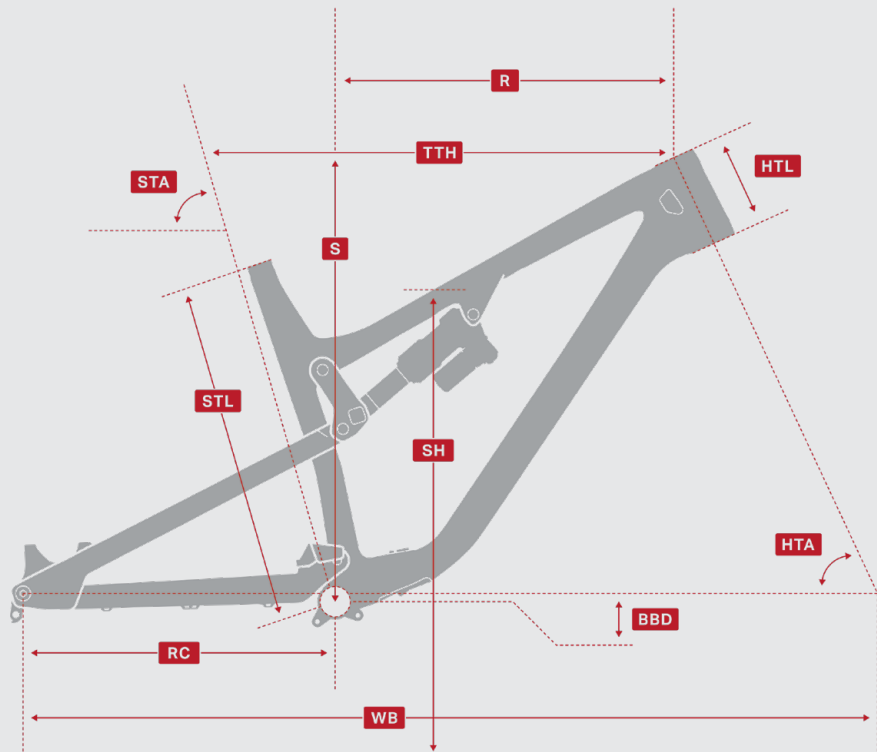

	XS			SM			MD			LG			XL		
	Slack	Neutral	Steep	Slack	Neutral	Steep	Slack	Neutral	Steep	Slack	Neutral	Steep	Slack	Neutral	Steep
HTA	65°	65.6°	66.1°	65°	65.6°	66.1°	65°	65.6°	66.1°	65°	65.6°	66.1°	65°	65.6°	66.1°
STA	74°	74.6°	75.1°	74°	74.6°	75.1°	74°	74.6°	75.1°	74°	74.6°	75.1°	74°	74.6°	75.1°
STL	368	368	368	394	394	394	432	432	432	471	471	471	509	509	509
TTH	548	546	545	578	576	575	603	601	600	628	626	625	658	656	655
HTL	100	100	100	110	110	110	120	120	120	130	130	130	145	145	145
RC	426	425	426	426	425	426	426	425	426	426	425	426	426	425	426
BBD	13	7	-1	13	7	-1	13	7	-1	13	7	-1	13	7	-1
SH	814	817	820	814	817	820	814	817	820	814	817	820	814	817	820
WB	1122	1120	1119	1153	1152	1150	1180	1179	1177	1206	1205	1204	1239	1238	1236
R	380	385	391	407	413	419	430	435	441	452	458	464	479	484	490
S	589	528	578	595	591	587	604	600	596	613	610	605	628	623	619

ALTITUDE COLOURWAYS

Carbon 90 / 70 / 50

COLOUR 1

Altitude Carbon 90 shown



SURFIN' BIRD
GLOSS

FOLSOM PRISON BLUE
GLOSS

SCHOOL'S OUT
GLOSS

Carbon 90 / 70 / 50

COLOUR 2

Altitude Carbon 90 shown



THE MAN IN BLACK
GLOSS

BROWN SUGAR
GLOSS

VOLCANO SUGAR
GLOSS

ALTITUDE COLOURWAYS

Carbon Frameset

COLOUR 1



SURFIN' BIRD
GLOSS

FOLSOM PRISON BLUE
GLOSS

SCHOOL'S OUT
GLOSS

Carbon Frameset

COLOUR 2



THE MAN IN BLACK
GLOSS

BROWN SUGAR
GLOSS

VOLCANO
GLOSS

B0023

MSRP

Altitude Carbon 90

MODEL HIGHLIGHTS

- Enduro World Series winning platform
- Perfect blend of pedaling efficiency, small bump sensitivity, and the ability to charge hard
- One of the lightest in the category
- RIDE-9 Geometry adjustment tailors bike to suit the rider & terrain

IMPROVEMENTS OVER PREVIOUS MODEL

- Short offset fork for high speed stability
- Shimano XTR 4 piston brakes
- Race Face carbon crank
- Stronger spokes

COLOUR 1



SURFIN' BIRD
GLOSS

FOLSOM PRISON BLUE
GLOSS

SCHOOL'S OUT
GLOSS

COLOUR 2



THE MAN IN BLACK
GLOSS

BROWN SUGAR
GLOSS

VOLCANO
GLOSS

Front Triangle

Smoothwall Carbon. Full Sealed Cartridge Bearings. Press Fit BB. Internal Cable Routing. 2-Bolt ISCG05 Tabs. RIDE-9 Adjustable Geometry + Suspension Rate. 150mm Travel.

Chainstay

Smoothwall Carbon

Seatstay

Smoothwall Carbon

Fork

Fox 36 Float EVOL GRIP2 Factory 160mm 37mm Offset

Rear Shock

Fox Float DPX2 Factory

F / Brake

Shimano XTR Trail 4 Piston

R / Brake

Shimano XTR Trail 4 Piston

F / Rotor

Shimano RT86 180mm

R / Rotor

Shimano RT86 180mm

R / Shifter

Shimano XTR

R / Derailleur

Shimano XTR

Crankset

Race Face Next R Cinch 34T

Chainguide

Rocky Mountain Spirit Guide

Bottom Bracket

Race Face BB92 30mm

Cassette

Shimano XTR 12s 10-51T

Chain

Shimano XTR 12s

F / Hub

Rocky Mountain Sealed Boost 15mm

R / Hub

DT Swiss 350 Boost 148mm

Spokes

DT Swiss Competition 2.0/1.8/2.0

F / Rim

Race Face ARC 30

R / Rim

Race Face ARC 30

F / Rim Tape

Tubeless Ready - Tape / Valves Incl.

R / Rim Tape

Tubeless Ready - Tape / Valves Incl.

F / Tire

Maxxis Minion DHF WT Maxx Terra 3C Tubeless Ready 27.5 x 2.5

R / Tire

Maxxis Aggressor WT EXO Tubeless Ready 27.5 x 2.5

Headset

FSA Orbit NO.57E

Stem

Rocky Mountain 35 CNC

Handlebar

Race Face Next R 780mm

Grips / Tape

Rocky Mountain Lock On XC

Seatpost

Race Face Turbine R (by Fox) Dropper 30.9mm

Saddle

WTB Volt Race 142

B0024

MSRP

Altitude Carbon 70

MODEL HIGHLIGHTS

- Enduro World Series winning platform
- Smart spec leaves nothing to be upgraded
- One of the lightest in the category
- RIDE-9 Geometry adjustment tailors bike to suit the rider & terrain

IMPROVEMENTS OVER PREVIOUS MODEL

- Short offset fork for high speed stability
- Shimano XT 4 piston brakes
- New Shimano 12spd drivetrain
- Stronger spokes
- Adjustable OneUp components dropper post

COLOUR 1



SURFIN' BIRD
GLOSS

FOLSOM PRISON BLUE
GLOSS

SCHOOL'S OUT
GLOSS

COLOUR 2



THE MAN IN BLACK
GLOSS

BROWN SUGAR
GLOSS

VOLCANO
GLOSS

Front Triangle

Smoothwall Carbon. Full Sealed Cartridge Bearings. Press Fit BB. Internal Cable Routing. 2-Bolt ISCG05 Tabs. RIDE-9 Adjustable Geometry + Suspension Rate. 150mm Travel.

Chainstay

Smoothwall Carbon

Seatstay

Smoothwall Carbon

Fork

Fox 36 Float EVOL GRIP2 Performance Elite 160mm 37mm Offset

Rear Shock

Fox Float DPX2 Performance

F / Brake

Shimano XT Trail 4 Piston

R / Brake

Shimano XT Trail 4 Piston

F / Rotor

Shimano RT66 180mm

R / Rotor

Shimano RT66 180mm

R / Shifter

Shimano XT

R / Derailleur

Shimano XT

Crankset

Race Face Turbine Cinch 34T

Chainguide

Rocky Mountain Spirit Guide

Bottom Bracket

Race Face BB92 30mm

Cassette

Shimano XT 10-51T

Chain

Shimano HG8100

F / Hub

Rocky Mountain Sealed Boost 15mm

R / Hub

DT Swiss 370 Boost 148mm

Spokes

DT Swiss Competition 2.0/1.8/2.0

F / Rim

Race Face ARC 30

R / Rim

Race Face ARC 30

F / Rim Tape

Tubeless Ready - Tape / Valves Incl.

R / Rim Tape

Tubeless Ready - Tape / Valves Incl.

F / Tire

Maxxis Minion DHF WT Maxx Terra 3C Tubeless Ready 27.5 x 2.5

R / Tire

Maxxis Aggressor WT EXO Tubeless Ready 27.5 x 2.5

Headset

FSA Orbit NO.57E

Stem

Rocky Mountain 35 AM

Handlebar

Race Face Turbine R 780mm

Grips / Tape

Rocky Mountain Lock On XC

Seatpost

OneUp Dropper Post 30.9mm

Saddle

WTB Volt Race 142

B0025

MSRP

Altitude Carbon 50

MODEL HIGHLIGHTS

- Enduro World Series winning platform
- No compromise DH performance, climbs like a trail bike
- One of the lightest in the category
- RIDE-9 Geometry adjustment tailors bike to suit the rider & terrain

IMPROVEMENTS OVER PREVIOUS MODEL

- Short offset fork for high speed stability
- Shimano SLX 4 piston brakes
- New Shimano 12spd drivetrain

COLOUR 1



SURFIN' BIRD
GLOSS

FOLSOM PRISON BLUE
GLOSS

SCHOOL'S OUT
GLOSS

COLOUR 2



THE MAN IN BLACK
GLOSS

BROWN SUGAR
GLOSS

VOLCANO
GLOSS

Front Triangle	Smoothwall Carbon. Full Sealed Cartridge Bearings. Press Fit BB. Internal Cable Routing. 2-Bolt ISCG05 Tabs. RIDE-9 Adjustable Geometry + Suspension Rate. 150mm Travel.
Chainstay	FORM Alloy
Seatstay	FORM Alloy
Fork	RockShox Lyrik Select RC 160mm 37mm Offset
Rear Shock	RockShox Super Deluxe Select+
F / Brake	Shimano SLX Trail 4 Piston
R / Brake	Shimano SLX Trail 4 Piston
F / Rotor	Shimano RT66 180mm
R / Rotor	Shimano RT66 180mm
R / Shifter	Shimano SLX
R / Derailleur	Shimano XT
Crankset	Race Face Aeffect Cinch 34T Steel
Chainguide	Rocky Mountain Spirit Guide
Bottom Bracket	Shimano SM-BBMT500
Cassette	Shimano SLX 10-51T
Chain	Shimano HG7100
F / Hub	Rocky Mountain Sealed Boost 15mm Torque Cap
R / Hub	DT Swiss 370 Boost 148mm
Spokes	DT Swiss Competition 2.0/1.8/2.0
F / Rim	WTB ST Light i30 TCS 2.0 Tubeless
R / Rim	WTB ST Light i30 TCS 2.0 Tubeless
F / Rim Tape	Tubeless Ready - Tape / Valves Incl.
R / Rim Tape	Tubeless Ready - Tape / Valves Incl.
F / Tire	Maxxis Minion DHF WT EXO Tubeless Ready 27.5 x 2.5
R / Tire	Maxxis Aggressor WT EXO Tubeless Ready 27.5 x 2.5
Headset	FSA Orbit NO.57E
Stem	Rocky Mountain 35 AM
Handlebar	Rocky Mountain AM 780mm
Grips / Tape	Rocky Mountain Lock On XC
Seatpost	Race Face Aeffect R Dropper 30.9mm
Saddle	WTB Volt Race 142

F0005

MSRP

Altitude Carbon FRAMESET

MODEL HIGHLIGHTS

- Enduro World Series winning platform
- Perfect blend of pedaling efficiency, small bump sensitivity, and the ability to charge hard
- One of the lightest in the category
- RIDE-9 Geometry adjustment tailors bike to suit the rider & terrain

COLOUR 1



SURFIN' BIRD
GLOSS

FOLSOM PRISON BLUE
GLOSS

SCHOOL'S OUT
GLOSS

COLOUR 2



THE MAN IN BLACK
GLOSS

BROWN SUGAR
GLOSS

VOLCANO
GLOSS

Front Triangle

Smoothwall Carbon. Full Sealed Cartridge Bearings. Press Fit BB. Internal Cable Routing. 2-Bolt ISCG05 Tabs. RIDE-9 Adjustable Geometry + Suspension Rate. 150mm Travel.

Chainstay

Smoothwall Carbon

Seatstay

Smoothwall Carbon

Rear Shock

Fox Float DPX2 Factory

Chainguide

Rocky Mountain Spirit Guide

ALTITUDE COLOURWAYS

Alloy 50 / 30

COLOUR 1

Altitude Alloy 50 shown



SURFIN' BIRD
GLOSS

BACK IN BLACK
GLOSS

SCHOOL'S OUT
GLOSS

Alloy 50 / 30

COLOUR 2

Altitude Alloy 50 shown



BROWN SUGAR
GLOSS

THE MAN IN BLACK
GLOSS

VOLCANO
GLOSS

B0026

MSRP

Altitude Alloy 50

MODEL HIGHLIGHTS

- Enduro World Series winning platform
- No compromise DH performance, climbs like a trail bike
- One of the lightest in the category
- RIDE-9 Geometry adjustment tailors bike to suit the rider & terrain

IMPROVEMENTS OVER PREVIOUS MODEL

- Short offset fork for high speed stability
- Shimano SLX 4 piston brakes
- New Shimano 12spd drivetrain
- Tubeless Ready
- DT Swiss rear hub

COLOUR 1



SURFIN' BIRD
GLOSS

BACK IN BLACK
GLOSS

SCHOOL'S OUT
GLOSS

COLOUR 2



BROWN SUGAR
GLOSS

THE MAN IN BLACK
GLOSS

VOLCANO
GLOSS

Image for colour and graphic reference only. Please refer to specification table.

Front Triangle	FORM Alloy. Full Sealed Cartridge Bearings. Press Fit BB. Internal Cable Routing. 2-Bolt ISCG05 Tabs. RIDE-9 Adjustable Geometry + Suspension Rate. 150mm Travel.
Chainstay	FORM Alloy
Seatstay	FORM Alloy
Fork	RockShox Lyrik Select RC 160mm 37mm Offset
Rear Shock	RockShox Super Deluxe Select+
F / Brake	Shimano SLX Trail 4 Piston
R / Brake	Shimano SLX Trail 4 Piston
F / Rotor	Shimano RT66 180mm
R / Rotor	Shimano RT66 180mm
R / Shifter	Shimano SLX
R / Derailleur	Shimano XT
Crankset	Race Face Aeffect Cinch 34T Steel
Chainguide	Rocky Mountain Spirit Guide
Bottom Bracket	Shimano SM-BBMT500
Cassette	Shimano SLX 10-51T
Chain	Shimano HG7100
F / Hub	Rocky Mountain Sealed Boost 15mm Torque Cap
R / Hub	DT Swiss 370 Boost 148mm
Spokes	DT Swiss Competition 2.0/1.8/2.0
F / Rim	WTB ST Light i30 TCS 2.0 Tubeless
R / Rim	WTB ST Light i30 TCS 2.0 Tubeless
F / Rim Tape	Tubeless Ready - Tape / Valves Incl.
R / Rim Tape	Tubeless Ready - Tape / Valves Incl.
F / Tire	Maxxis Minion DHF WT EXO Tubeless Ready 27.5 x 2.5
R / Tire	Maxxis Aggressor WT EXO Tubeless Ready 27.5 x 2.5
Headset	FSA Orbit NO.57E
Stem	Rocky Mountain 35 AM
Handlebar	Rocky Mountain AM 780mm
Grips / Tape	Rocky Mountain Lock On XC
Seatpost	Race Face Aeffect R Dropper 30.9mm
Saddle	WTB Volt Race 142

Specifications are subject to change without notice.

B0027

MSRP

Altitude Alloy 30

MODEL HIGHLIGHTS

- Super wide range drivetrain at a reasonable price
- RIDE-9 Geometry adjustment tailors bike to suit the rider & terrain

IMPROVEMENTS OVER PREVIOUS MODEL

- Short offset fork for high speed stability
- Shimano 4 piston brakes
- New Sram SX Eagle 12spd drivetrain
- Tubeless ready
- Rocky Mountain Toonie Drop post

COLOUR 1



SURFIN' BIRD
GLOSS

BACK IN BLACK
GLOSS

SCHOOL'S OUT
GLOSS

COLOUR 2



BROWN SUGAR
GLOSS

THE MAN IN BLACK
GLOSS

VOLCANO
GLOSS

Front Triangle

FORM Alloy. Full Sealed Cartridge Bearings. Press Fit BB. Internal Cable Routing. 2-Bolt ISCG05 Tabs. RIDE-9 Adjustable Geometry + Suspension Rate. 150mm Travel.

Chainstay

FORM Alloy

Seatstay

FORM Alloy

Fork

RockShox Yari RC 160mm 37mm Offset

Rear Shock

RockShox Deluxe Select+ RT

F / Brake

Shimano MT420 4 Piston

R / Brake

Shimano MT420 4 Piston

F / Rotor

Shimano RT64 180mm

R / Rotor

Shimano RT64 180mm

R / Shifter

Sram SX Eagle

R / Derailleur

Sram SX Eagle

Crankset

Sram SX Eagle 34T

Chainguide

Rocky Mountain Spirit Guide

Bottom Bracket

Sram BB92 DUB

Cassette

Sram PG-1210 11-50T

Chain

Sram SX Eagle

F / Hub

Shimano MT400 Boost 15mm

R / Hub

Shimano MT400 Boost 148mm

Spokes

2.0 Stainless

F / Rim

WTB ST Light i30 TCS 2.0 Tubeless

R / Rim

WTB ST Light i30 TCS 2.0 Tubeless

F / Rim Tape

Tubeless Ready - Tape / Valves Incl.

R / Rim Tape

Tubeless Ready - Tape / Valves Incl.

F / Tire

Maxxis Minion DHF WT EXO
Tubeless Ready 27.5 x 2.5

R / Tire

Maxxis Aggressor WT EXO
Tubeless Ready 27.5 x 2.5

Headset

FSA Orbit NO.57E

Stem

Rocky Mountain 35 AM

Handlebar

Rocky Mountain AM 780mm

Grips / Tape

Rocky Mountain Lock On XC

Seatpost

Rocky Mountain Toonie Drop 30.9mm

Saddle

WTB Volt Race 142

SLAYER

DESIGNED FOR
Big Mountain

FRONT TRAVEL
180 & 170 MM

REAR TRAVEL
180 & 170 MM

WHEEL SIZE
27.5" & 29"

NOTES

NEW FOR 2020!

The ultimate big mountain platform, the Slayer is meant for riding fast and sending it deep. Designed to be able to pedal to the top of any mega descent, this bike allows you to shred corners, hit gaps, and ride harder than you ever thought possible.

Whether you're smashing through the roughest trails imaginable or scrubbing lips in the park, the Slayer is built for those who charge. We've made it longer and slacker, with better small-bump sensitivity and a more progressive end-stroke. For those who like to fine tune their ride before they shred, we kept the RIDE-4 adjustment system to allow for further geometry and ride feel customization. Rocky Mountain led the original freeride movement, and the Slayer continues the legacy.

FRAME TECHNOLOGY



Smoothwall Carbon
FRAME MATERIAL



FORM Alloy
FRAME MATERIAL



Smoothlink
SUSPENSION



RIDE-4
ADJUSTMENT SYSTEM



Size Specific
TUNE

Rider:
Thomas Vanderham

Photo:
Margus Riga

Location:
Kamloops, BC



SLAYER CARBON & ALLOY

GEOMETRY

Geometry shown for Slack and Steep RIDE-4 positions.

- HTA** Head Tube Angle (deg)
- STA** Seat Tube Angle (deg)
- STL** Seat Tube Length (mm)
- TTH** Top Tube Horizontal (mm)
- HTL** Head Tube Length (mm)
- RC** Rear Centre (mm)
- BBD** Bottom Bracket Drop (mm)
- SH** Standover Height (mm)
- WB** Wheelbase (mm)
- R** Reach (mm)
- S** Stack (mm)

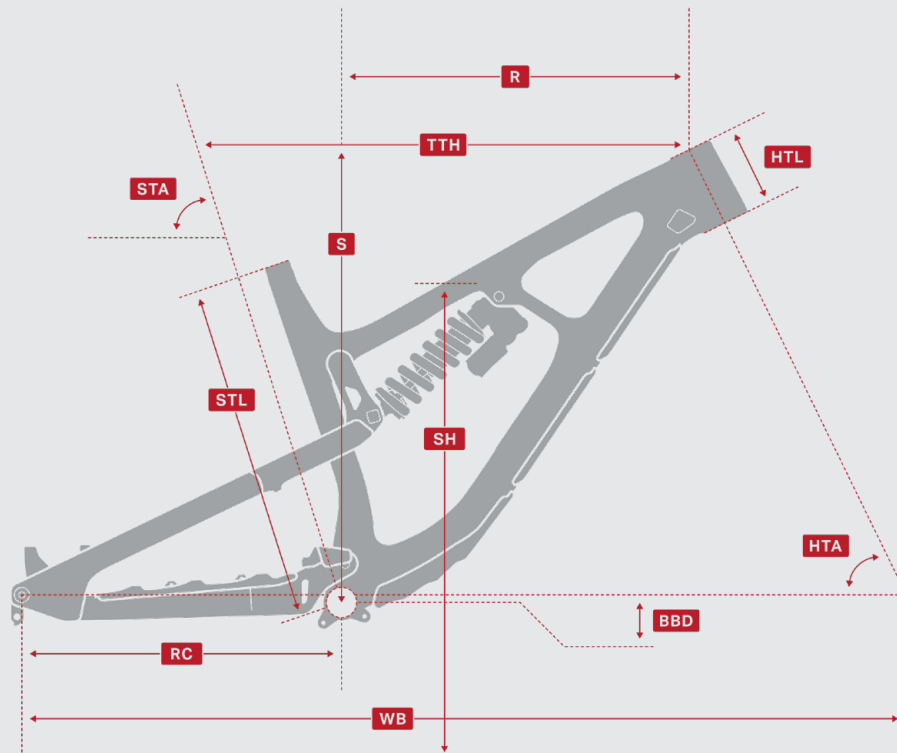

Slayer 29"

Slayer 27.5"

	Slayer 29"						Slayer 27.5"							
	MD		LG		XL		SM		MD		LG		XL	
	Slack	Steep	Slack	Steep	Slack	Steep	Slack	Steep	Slack	Steep	Slack	Steep	Slack	Steep
HTA	63.8°	64.8°	63.8°	64.8°	63.8°	64.8°	63.9°	64.8°	63.9°	64.8°	63.9°	64.8°	63.9°	64.8°
STA	75.8°	76.8°	75.8°	76.8°	75.8°	76.8°	75.4°	76.3°	75.4°	76.3°	75.4°	76.3°	75.4°	76.3°
STL	420	420	445	445	480	480	380	380	420	420	460	460	480	480
TTH	600	595	628	623	657	652	574	572	598	596	624	621	660	658
HTL	95	95	110	110	125	125	90	90	95	95	110	110	125	125
RC	443	441	443	441	443	441	431	429	431	429	431	429	431	429
BBD	34	18	34	18	34	18	18	6	18	6	18	6	18	6
SH	830	833	830	833	830	833	806	811	806	811	806	811	806	811
WB	1220	1215	1249	1244	1286	1281	1180	1177	1205	1202	1234	1231	1273	1270
R	462	453	469	478	492	503	419	428	444	453	469	478	494	503
S	622	614	635	627	649	641	595	589	600	594	614	608	627	621

SLAYER COLOURWAYS

Carbon 90 / 70
Carbon 50 (29" only)

COLOUR 1

Slayer Carbon 90 (29") shown



THE MAN IN BLACK
GLOSS

HEARTBREAKER
GLOSS

BRASS MONKEY
GLOSS

Carbon 90 / 70
Carbon 50 (29" only)

COLOUR 2

Slayer Carbon 90 (29") shown



THE MAN IN BLACK
GLOSS

TOUCH OF GREY
GLOSS

SLAYER COLOURWAYS

Carbon Frameset

COLOUR 1

Slayer Carbon Frameset (29") shown



Carbon Frameset

COLOUR 2

Slayer Carbon Frameset (29") shown



29": B0032 / 27.5": B0028

MSRP

Slayer Carbon 90

MODEL HIGHLIGHTS

- DH park worthy strong and stiff frame
- Smoothwall Carbon front triangle
- Fully guided internal housing
- Fully shielded bearings

COLOUR 1



THE MAN IN BLACK
GLOSS

HEARTBREAKER
GLOSS

BRASS MONKEY
GLOSS

COLOUR 2



THE MAN IN BLACK
GLOSS

TOUCH OF GREY
GLOSS

Front Triangle

Smoothwall Carbon. Full Sealed Cartridge Bearings. Press Fit BB. Internal Cable Routing. RIDE-4 Adjustable Geometry. 29: 170mm Travel / 27.5: 180mm Travel.

Chainstay

FORM Alloy

Seatstay

FORM Alloy

Fork

Fox 36 Float EVOL GRIP2 Factory 29: 170mm 44mm Offset / 27.5: 180mm 37mm Offset

Rear Shock

Fox DHX2 Factory, 2-Position Lockout, SLS Spring

F / Brake

Shimano XTR Trail 4 Piston

R / Brake

Shimano XTR Trail 4 Piston

F / Rotor

Shimano RT86 203mm

R / Rotor

Shimano RT86 203mm

R / Shifter

Shimano XTR

R / Derailleur

Shimano XTR

Crankset

Race Face Next R Cinch 29: 32T / 27.5: 34T

Chainguide

Rocky Mountain Spirit Guide + OneUp 2-Bolt ISCG Bash

Bottom Bracket

Race Face BB92 30mm

Cassette

Shimano XTR 12s 10-51T

Chain

Shimano XTR 12s

F / Hub

Rocky Mountain Sealed Boost 15mm

R / Hub

DT Swiss 350 Boost 148mm

Spokes

DT Swiss Champion 2.0

F / Rim

Race Face ARC 30

R / Rim

Race Face ARC 30

F / Rim Tape

Tubeless Ready - Tape / Valves Incl.

R / Rim Tape

Tubeless Ready - Tape / Valves Incl.

F / Tire

Maxxis Minion DHF WT Double Down Maxx Grip 3C Tubeless Ready 2.5

R / Tire

Maxxis Aggressor WT Double Down Tubeless Ready 2.5

Headset

FSA Orbit NO.57E

Stem

Rocky Mountain 35 CNC

Handlebar

Race Face SixC 820mm

Grips / Tape

Rocky Mountain Lock On XC

Seatpost

Race Face Turbine R (by Fox) Dropper 30.9mm

Saddle

WTB Volt Race 142

29": B0033 / 27.5": B0029

MSRP

Slayer Carbon 70

MODEL HIGHLIGHTS

- DH park worthy strong and stiff frame
- Smoothwall Carbon front triangle
- Fully guided internal housing
- Fully shielded bearings

COLOUR 1



THE MAN IN BLACK
GLOSS

HEARTBREAKER
GLOSS

BRASS MONKEY
GLOSS

COLOUR 2



THE MAN IN BLACK
GLOSS

TOUCH OF GREY
GLOSS

Front Triangle	Smoothwall Carbon. Full Sealed Cartridge Bearings. Press Fit BB. Internal Cable Routing. RIDE-4 Adjustable Geometry. 29: 170mm Travel / 27.5: 180mm Travel.
Chainstay	FORM Alloy
Seatstay	FORM Alloy
Fork	RockShox Lyrik Ultimate RC2 29: 170mm 42mm Offset / 27.5: 180mm 37mm Offset
Rear Shock	RockShox Super Deluxe Coil Ultimate RCT
F / Brake	Shimano XT Trail 4 Piston
R / Brake	Shimano XT Trail 4 Piston
F / Rotor	Shimano RT66 203mm
R / Rotor	Shimano RT66 203mm
R / Shifter	Shimano XT
R / Derailleur	Shimano XT
Crankset	Race Face Turbine Cinch 29: 32T / 27.5: 34T
Chainguide	Rocky Mountain Spirit Guide + OneUp 2-Bolt ISCG Bash
Bottom Bracket	Race Face BB92 30mm
Cassette	Shimano XT 10-51T
Chain	Shimano HG8100
F / Hub	Rocky Mountain Sealed Boost 15mm Torque Cap
R / Hub	DT Swiss 370 Boost 148mm
Spokes	DT Swiss Champion 2.0
F / Rim	Race Face AR 30
R / Rim	Race Face AR 30
F / Rim Tape	Tubeless Ready - Tape / Valves Incl.
R / Rim Tape	Tubeless Ready - Tape / Valves Incl.
F / Tire	Maxxis Minion DHF WT Double Down Maxx Grip 3C Tubeless Ready 2.5
R / Tire	Maxxis Aggressor WT Double Down Tubeless Ready 2.5
Headset	FSA Orbit NO.57E
Stem	Rocky Mountain 35 AM
Handlebar	Race Face Atlas 820mm
Grips / Tape	Rocky Mountain Lock On XC
Seatpost	OneUp Dropper Post 30.9mm
Saddle	WTB Volt Race 142

B0034

MSRP

Slayer Carbon 50

MODEL HIGHLIGHTS

- DH park worthy strong and stiff frame
- Smoothwall Carbon front triangle
- Fully guided internal housing
- Fully shielded bearings

COLOUR 1



THE MAN IN BLACK
GLOSS

HEARTBREAKER
GLOSS

BRASS MONKEY
GLOSS

COLOUR 2



THE MAN IN BLACK
GLOSS

TOUCH OF GREY
GLOSS

Front Triangle	Smoothwall Carbon. Full Sealed Cartridge Bearings. Press Fit BB. Internal Cable Routing. RIDE-4 Adjustable Geometry. 170mm Travel
Chainstay	FORM Alloy
Seatstay	FORM Alloy
Fork	RockShox Lyrik Select RC 170mm 42mm Offset
Rear Shock	RockShox Super Deluxe Coil Ultimate RCT
F / Brake	Shimano SLX Trail 4 Piston
R / Brake	Shimano SLX Trail 4 Piston
F / Rotor	Shimano RT66 203mm
R / Rotor	Shimano RT66 203mm
R / Shifter	Shimano SLX
R / Derailleur	Shimano XT
Crankset	Race Face Aeffect Cinch 32T Steel
Chainguide	Rocky Mountain Spirit Guide + OneUp 2-Bolt ISCG Bash
Bottom Bracket	Shimano SM-BBMT500
Cassette	Shimano SLX 10-51T
Chain	Shimano HG7100
F / Hub	Rocky Mountain Sealed Boost 15mm Torque Cap
R / Hub	DT Swiss 370 Boost 148mm
Spokes	DT Swiss Champion 2.0
F / Rim	WTB ST i30 TCS 2.0 Tubeless
R / Rim	WTB ST i30 TCS 2.0 Tubeless
F / Rim Tape	Tubeless Ready - Tape / Valves Incl.
R / Rim Tape	Tubeless Ready - Tape / Valves Incl.
F / Tire	Maxxis Minion DHF Double Down Maxx Grip 3C Tubeless Ready 2.5
R / Tire	Maxxis Aggressor WT Double Down Tubeless Ready 2.5
Headset	FSA Orbit NO.57E
Stem	Rocky Mountain 35 AM
Handlebar	Rocky Mountain AM 780mm
Grips / Tape	Rocky Mountain Lock On XC
Seatpost	OneUp Dropper Post 30.9mm
Saddle	WTB Volt Race 142

29": F0007 / 27.5": F0006

MSRP

Slayer Carbon FRAMESET

MODEL HIGHLIGHTS

- DH park worthy strong and stiff frame
- Smoothwall Carbon front triangle
- Fully guided internal housing
- Fully shielded bearings

COLOUR 1



THE MAN IN BLACK
GLOSS

HEARTBREAKER
GLOSS

BRASS MONKEY
GLOSS

COLOUR 2



THE MAN IN BLACK
GLOSS

TOUCH OF GREY
GLOSS

Front Triangle

Smoothwall Carbon. Full Sealed Cartridge Bearings. Press Fit BB. Internal Cable Routing. RIDE-4 Adjustable Geometry, 29: 170mm Travel / 27.5: 180mm Travel.

Chainstay

FORM Alloy

Seatstay

FORM Alloy

Rear Shock

Fox DHX2 Factory, 2-Position Lockout, SLS Spring

Chainguide

Rocky Mountain Spirit Guide

SLAYER COLOURWAYS

Alloy 50 / 30

COLOUR 1

Slayer Alloy 50 (29") shown



THE MAN IN BLACK
MATTE

HEARTBREAKER
GLOSS

BRASS MONKEY
GLOSS

Alloy 50 / 30

COLOUR 2

Slayer Alloy 50 (29") shown



TOUCH OF GREY
MATTE

BACK IN BLACK
GLOSS

29": B0099 / 27.5": B0030

MSRP

Slayer Alloy 50

MODEL HIGHLIGHTS

- DH park worthy strong and stiff frame
- Next generation FORM Alloy frameset
- Fully shielded bearings

COLOUR 1



THE MAN IN BLACK
MATTE

HEARTBREAKER
GLOSS

BRASS MONKEY
GLOSS

COLOUR 2



TOUCH OF GREY
MATTE

BACK IN BLACK
GLOSS

Front Triangle

FORM Alloy. Full Sealed Cartridge Bearings. Press Fit BB. Internal Cable Routing. 2-Bolt ISCG05 Tabs. RIDE-4 Adjustable Geometry + Suspension Rate. 29: 170mm Travel / 27.5: 180mm Travel.

Chainstay

FORM Alloy

Seatstay

FORM Alloy

Fork

RockShox Lyrik Select RC 29: 170mm 42mm Offset / 27.5: 180mm 37mm Offset

Rear Shock

RockShox Super Deluxe Coil Ultimate RCT

F / Brake

Shimano SLX Trail 4 Piston

R / Brake

Shimano SLX Trail 4 Piston

F / Rotor

Shimano RT66 203mm

R / Rotor

Shimano RT66 203mm

R / Shifter

Shimano SLX

R / Derailleur

Shimano XT

Crankset

Race Face Aeffect Cinch 29: 32T / 27.5: 34T

Chainguide

Rocky Mountain Spirit Guide + OneUp 2-Bolt ISCG Bash

Bottom Bracket

Shimano SM-BBMT500

Cassette

Shimano SLX 10-51T

Chain

Shimano HG7100

F / Hub

Rocky Mountain Sealed Boost 15mm Torque Cap

R / Hub

DT Swiss 370 Boost 148mm

Spokes

DT Swiss Champion 2.0

F / Rim

WTB ST i30 TCS 2.0 Tubeless

R / Rim

WTB ST i30 TCS 2.0 Tubeless

F / Rim Tape

Tubeless Ready - Tape / Valves Incl.

R / Rim Tape

Tubeless Ready - Tape / Valves Incl.

F / Tire

Maxxis Minion DHF WT Double Down
Maxx Grip 3C Tubeless Ready 2.5

R / Tire

Maxxis Aggressor WT Double Down
Tubeless Ready 2.5

Headset

FSA Orbit NO.57E

Stem

Rocky Mountain 35 AM

Handlebar

Rocky Mountain AM 780mm

Grips / Tape

Rocky Mountain Lock On XC

Seatpost

Race Face Aeffect R Dropper 30.9mm

Saddle

WTB Volt Race 142

29": B0100 / 27.5": B0031

MSRP

Slayer Alloy 30

MODEL HIGHLIGHTS

- DH park worthy strong and stiff frame
- Next generation FORM Alloy frameset
- Fully shielded bearings

COLOUR 1



THE MAN IN BLACK
MATTE

HEARTBREAKER
GLOSS

BRASS MONKEY
GLOSS

COLOUR 2



TOUCH OF GREY
MATTE

BACK IN BLACK
GLOSS

Front Triangle

FORM Alloy. Full Sealed Cartridge Bearings. Press Fit BB. Internal Cable Routing. 2-Bolt ISCG05 Tabs. RIDE-4 Adjustable Geometry + Suspension Rate. 29: 170mm Travel / 27.5: 180mm Travel.

Chainstay

FORM Alloy

Seatstay

FORM Alloy

Fork

RockShox Yari RC 29: 170mm 42mm Offset / 27.5: 180mm 37mm Offset

Rear Shock

RockShox Super Deluxe Coil Select

F / Brake

Shimano MT520 4 Piston

R / Brake

Shimano MT520 4 Piston

F / Rotor

Shimano RT64 203mm

R / Rotor

Shimano RT64 203mm

R / Shifter

Sram SX Eagle

R / Derailleur

Sram SX Eagle

Crankset

Sram SX Eagle 29: 32T / 27.5: 34T

Chainguide

Rocky Mountain Spirit Guide + OneUp 2-Bolt ISCG Bash

Bottom Bracket

Sram BB92 DUB

Cassette

Sram PG-1210 11-50T

Chain

Sram SX Eagle

F / Hub

Shimano MT400 Boost 15mm

R / Hub

Shimano MT400 Boost 148mm

Spokes

2.0 Stainless

F / Rim

WTB ST i30 TCS 2.0 Tubeless

R / Rim

WTB ST i30 TCS 2.0 Tubeless

F / Rim Tape

Tubeless Ready - Tape / Valves Incl.

R / Rim Tape

Tubeless Ready - Tape / Valves Incl.

F / Tire

Maxxis Minion DHF WT Double Down
Maxx Grip 3C Tubeless Ready 2.5

R / Tire

Maxxis Aggressor WT Double Down
Tubeless Ready 2.5

Headset

FSA Orbit NO.57E

Stem

Rocky Mountain 35 AM

Handlebar

Rocky Mountain AM 780mm

Grips / Tape

Rocky Mountain Lock On XC

Seatpost

Rocky Mountain Toonie Drop 30.9mm

Saddle

WTB Volt Race 142

VERTEX

DESIGNED FOR
XC Race

FRONT TRAVEL
100 MM

WHEEL SIZE
**29" (27.5+
compatible)**

The Vertex embodies speed and confidence, sitting at the top of the food chain as our flagship XC-race hardtail.

Its lightweight frame provides incredible stiffness and rolling speed, while its modern, aggressive geometry inspires confidence everywhere on the race course—even technical corners and descents. Available in a next-generation Smoothwall HBO carbon layup for even lighter weight.

NOTES

Riders:
Lukas Baum & Sascha Weber

Photo:
Dennis Stratmann

Location:
Cadaques, Spain

FRAME TECHNOLOGY



Smoothwall Carbon
FRAME MATERIAL



VERTEX CARBON

GEOMETRY

- HTA** Head Tube Angle (deg)
- STA** Seat Tube Angle (deg)
- STL** Seat Tube Length (mm)
- TTH** Top Tube Horizontal (mm)
- HTL** Head Tube Length (mm)
- RC** Rear Centre (mm)
- BBD** Bottom Bracket Drop (mm)
- SH** Standover Height (mm)
- WB** Wheelbase (mm)
- R** Reach (mm)
- S** Stack (mm)

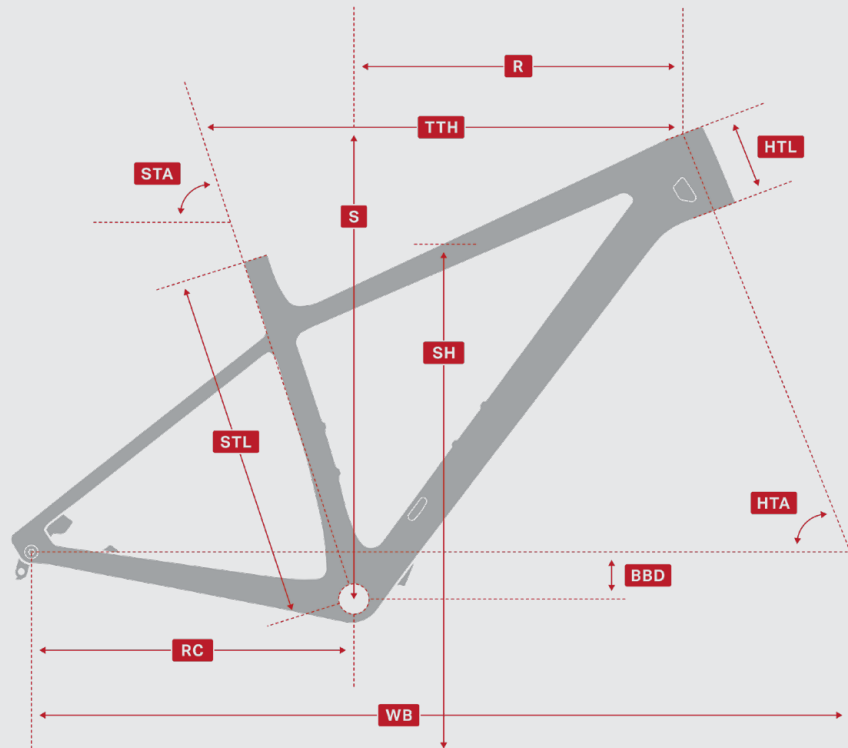

	SM	MD	LG	XL
HTA	69.5°	69.5°	69.5°	69.5°
STA	73.5°	73.5°	73.5°	73.5°
STL	394	432	470	508
TTH	575	600	625	650
HTL	90	95	110	125
RC	430	430	430	430
BBD	60	60	60	60
SH	799	806	806	847
WB	1076	1101	1127	1153
R	391	415	435	456
S	602	607	621	635

VERTEX COLOURWAYS

Carbon 90 / 70 / 50

COLOUR 1

Vertex Carbon 90 shown



Carbon Frameset

COLOUR 1

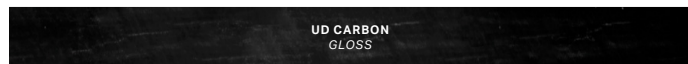

B0035

MSRP

Vertex Carbon 90

MODEL HIGHLIGHTS

- Rocky Mountain confident handling in an XC race package
- Superlight HBO layup saves 200g over standard frame
- Compatible with Shimano Di2 & 27.2mm dropper post
- Fits 27.5" x 2.8

COLOUR 1



UD CARBON
GLOSS

BRASS MONKEY
GLOSS

Frame	Smoothwall Carbon Super Hi Mod. Press Fit BB. Internal Cable Routing. 27.2mm Dropper Post Compatible
Fork	RockShox Sid Ultimate RLC Remote 100mm
F / Brake	Sram Level TLM
R / Brake	Sram Level TLM
F / Rotor	Sram Centerline 180mm
R / Rotor	Sram Centerline 180mm
R / Shifter	Sram X01 Eagle
R / Derailleur	Sram X01 Eagle
Crankset	Sram X1 Carbon Eagle 32T
Bottom Bracket	Sram BB92 DUB
Cassette	Sram XG-1295 10-50T
Chain	Sram X01 Eagle
F / Hub	Rocky Mountain Sealed Boost 15mm Torque Cap
R / Hub	DT Swiss 350 Boost 148mm
Spokes	DT Swiss Competition 1.8/1.6/1.8
F / Rim	Race Face ARC 25
R / Rim	Race Face ARC 25
F / Rim Tape	Tubeless Ready - Tape / Valves Incl.
R / Rim Tape	Tubeless Ready - Tape / Valves Incl.
F / Tire	Schwalbe Racing Ray 29 x 2.25 Evo Snakeskin
R / Tire	Schwalbe Racing Ralph 29 x 2.25 Evo Snakeskin
Headset	FSA Orbit NO.57E
Stem	Rocky Mountain 35 CNC
Handlebar	Race Face Next 760mm
Grips / Tape	Rocky Mountain Lock On XC
Seatpost	Rocky Mountain Carbon SL 27.2mm
Saddle	WTB Silverado Race 142

B0036

MSRP

Vertex Carbon 70

MODEL HIGHLIGHTS

- Rocky Mountain confident handling in an XC race package
- Superlight Fox Step Cast fork
- Compatible with Shimano Di2 & 27.2mm dropper post
- Fits 27.5" x 2.8

IMPROVEMENTS OVER PREVIOUS MODEL

- Shimano 12spd drivetrain
- Wider rims for grip & control
- Tubeless ready

COLOUR 1



UD CARBON
GLOSS

BRASS MONKEY
GLOSS

Frame	Smoothwall Carbon. Press Fit BB. Internal Cable Routing. 27.2mm Dropper Post Compatible
Fork	Fox 32 Step Cast Performance 100mm
F / Brake	Shimano XT
R / Brake	Shimano XT
F / Rotor	Shimano RT66 180mm
R / Rotor	Shimano RT66 180mm
R / Shifter	Shimano XT
R / Derailleur	Shimano XT
Crankset	Race Face Aeffect Cinch 32T
Bottom Bracket	Shimano SM-BB71
Cassette	Shimano XT 10-51T
Chain	Shimano HG8100
F / Hub	Rocky Mountain Sealed Boost 15mm
R / Hub	DT Swiss 370 Boost 148mm
Spokes	DT Swiss Competition 1.8/1.6/1.8
F / Rim	WTB ST Light i25 TCS 2.0 Tubeless
R / Rim	WTB ST Light i25 TCS 2.0 Tubeless
F / Rim Tape	Tubeless Ready - Tape / Valves Incl.
R / Rim Tape	Tubeless Ready - Tape / Valves Incl.
F / Tire	Schwalbe Racing Ray 29 x 2.25 Evo Snakeskin
R / Tire	Schwalbe Racing Ralph 29 x 2.25 Evo Snakeskin
Headset	FSA Orbit NO.57E
Stem	Rocky Mountain AM
Handlebar	Rocky Mountain Flat Top 760mm
Grips / Tape	Rocky Mountain Lock On Light
Seatpost	Rocky Mountain SL 27.2mm
Saddle	WTB Silverado Race 142

B0037

MSRP

Vertex Carbon 50

MODEL HIGHLIGHTS

- Rocky Mountain confident handling in an XC race package
- Compatible with Shimano Di2 & 27.2mm dropper post
- Fits 27.5" x 2.8

IMPROVEMENTS OVER PREVIOUS MODEL

- Shimano 12spd drivetrain
- Wider rims for grip & control
- Tubeless ready

COLOUR 1



UD CARBON
GLOSS

BRASS MONKEY
GLOSS

Frame	Smoothwall Carbon. Press Fit BB. Internal Cable Routing. 27.2mm Dropper Post Compatible
Fork	RockShox Reba RL 100mm
F / Brake	Shimano SLX
R / Brake	Shimano SLX
F / Rotor	Shimano RT66 180mm
R / Rotor	Shimano RT66 180mm
R / Shifter	Shimano XT
R / Derailleur	Shimano XT
Crankset	Race Face Ride Cinch 32T Steel
Bottom Bracket	Shimano SM-BBMT500
Cassette	Shimano SLX 10-51T
Chain	Shimano HG7100
F / Hub	Rocky Mountain Sealed Boost 15mm Torque Cap
R / Hub	DT Swiss 370 Boost 148mm
Spokes	DT Swiss Competition 2.0/1.8/2.0
F / Rim	WTB ST Light i25 TCS 2.0 Tubeless
R / Rim	WTB ST Light i25 TCS 2.0 Tubeless
F / Rim Tape	Tubeless Ready - Tape / Valves Incl.
R / Rim Tape	Tubeless Ready - Tape / Valves Incl.
F / Tire	Schwalbe Racing Ray 29 x 2.25 Performance Folding
R / Tire	Schwalbe Racing Ralph 29 x 2.25 Performance Folding
Headset	FSA Orbit NO.57E
Stem	Rocky Mountain AM
Handlebar	Rocky Mountain Flat Top 760mm
Grips / Tape	Rocky Mountain Lock On Light
Seatpost	Rocky Mountain SL 27.2mm
Saddle	WTB Silverado Race 142

F0009

MSRP

Vertex Carbon FRAMESET

MODEL HIGHLIGHTS

- Rocky Mountain confident handling in an XC race package
- Superlight HBO layup saves 200g over standard frame
- Compatible with Shimano Di2 & 27.2mm dropper post
- Fits 27.5" x 2.8

COLOUR 1



UD CARBON
GLOSS

BRASS MONKEY
GLOSS

Frame

Smoothwall Carbon Super Hi Mod. Press Fit BB. Internal Cable Routing. 27.2mm Dropper Post Compatible

Headset

FSA Orbit NO.57E Extend-o-matic

FUSION

DESIGNED FOR
Sport XC

FRONT TRAVEL
100 MM

WHEEL SIZE
29"

A perfect blend of efficiency and reliability, the Fusion has everything you need to get from A to B.

Designed for speed and efficiency, the fast-rolling 29" wheels and responsive handling will have you covering off-road paths and smooth singletrack kilometre after kilometre.

FRAME TECHNOLOGY



RMB 6061
ALLOY

NOTES

Rider:
Karen Stark

Photo:
Margus Riga

Location:
Vancouver, BC



FUSION

GEOMETRY

- HTA** Head Tube Angle (deg)
- STA** Seat Tube Angle (deg)
- STL** Seat Tube Length (mm)
- TTH** Top Tube Horizontal (mm)
- HTL** Head Tube Length (mm)
- RC** Rear Centre (mm)
- BBD** Bottom Bracket Drop (mm)
- SH** Standover Height (mm)
- WB** Wheelbase (mm)
- R** Reach (mm)
- S** Stack (mm)

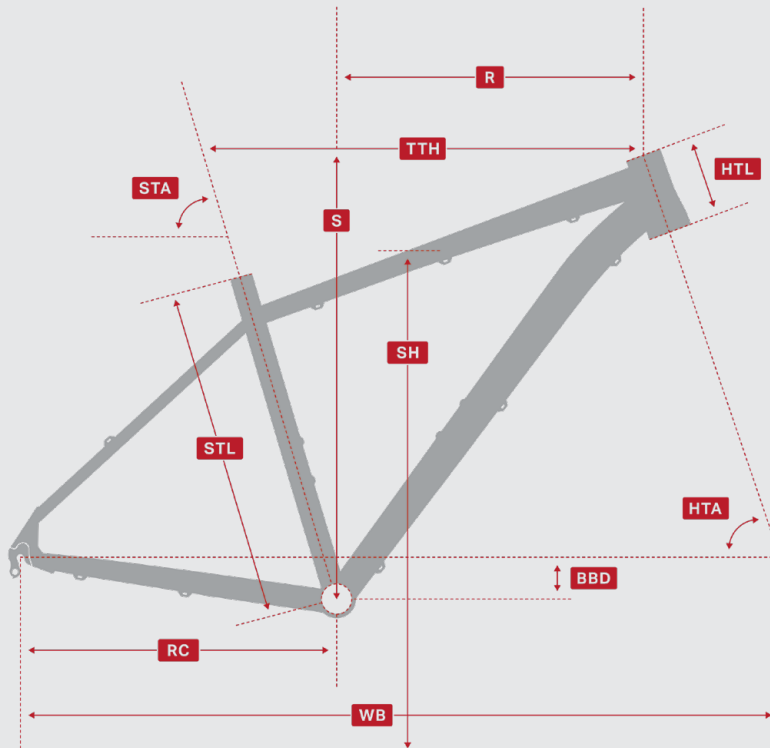

	SM	MD	LG	XL
HTA	69°	69.5°	69.5°	69.5°
STA	73.5°	73.5°	73°	73°
STL	394	432	470	508
TTH	575	600	625	655
HTL	100	100	110	120
RC	447	447	447	447
BBD	56	56	56	56
SH	809	820	843	860
WB	1100	1119	1139	1170
R	393	418	434	461
S	611	617	623	633

FUSION COLOURWAYS

Fusion 40

COLOUR 1



SMOKE ON THE WATER
MATTE

THE MAN IN BLACK
MATTE

YELLOW SUBMARINE
MATTE

Rider:
Karen Stark

Photo:
Margus Riga

Location:
Vancouver, BC



FUSION COLOURWAYS

Fusion 30

COLOUR 1



Fusion 30

COLOUR 2



FUSION COLOURWAYS

Fusion 10

COLOUR 1



FOLSOM PRISON BLUE
GLOSS

THE MAN IN BLACK
GLOSS

BILLY OCEAN
GLOSS

Fusion 10

COLOUR 2



FLAMING LIPS
GLOSS

THE MAN IN BLACK
GLOSS

SUNDAY BLOODY SUNDAY
GLOSS

B0044

MSRP

Fusion 40

MODEL HIGHLIGHTS

- Stable, easy going geometry & fit
- Vertex quickness with extra stability
- Lightweight alloy frame
- Simple & reliable 1x drivetrain

IMPROVEMENTS OVER PREVIOUS MODEL

- Wide range Sram Eagle drivetrain
- Wider rims & tires for grip and control
- Wider saddles for comfort
- Size specific grips - thicker diameter for bigger sizes

COLOUR 1



SMOKE ON THE WATER
MATTE

THE MAN IN BLACK
MATTE

YELLOW SUBMARINE
MATTE

Frame	Rocky Mountain 6061 Alloy, Threaded BB, Zero Stack Tapered Headtube
Fork	RockShox 30 Silver Fast Black TK Air 100mm
F / Brake	Shimano MT201
R / Brake	Shimano MT201
F / Rotor	Shimano RT10 160mm
R / Rotor	Shimano RT10 160mm
R / Shifter	Sram SX Eagle
R / Derailleur	Sram SX Eagle
Crankset	Sram SX Eagle Powerspline 30T
Bottom Bracket	Sram Powerspline
Pedals	Alloy Platform
Cassette	Sram PG-1210 11-50T
Chain	Sram SX Eagle
F / Hub	Shimano TX505
R / Hub	Shimano TX505
Spokes	2.0 Stainless
F / Rim	WTB ST i30 TCS 2.0 Tubeless
R / Rim	WTB ST i30 TCS 2.0 Tubeless
F / Tire	WTB Ranger Comp 29 x 2.4
R / Tire	WTB Ranger Comp 29 x 2.4
Headset	FSA No. 57B
Stem	Rocky Mountain XC
Handlebar	Rocky Mountain XC 760mm
Grips / Tape	Rocky Mountain Lock On Light
Seatpost	Rocky Mountain 27.2mm
Saddle	WTB Volt 142

B0045

MSRP

Fusion 30

MODEL HIGHLIGHTS

- Stable, easy going geometry & fit
- Vertex quickness with extra stability
- Lightweight alloy frame
- Simple & reliable 1x drivetrain

IMPROVEMENTS OVER PREVIOUS MODEL

- Chain guide for reliable chain retention
- Wider rims & tires for grip and control
- Wider saddles for comfort
- Size specific grips - thicker diameter for bigger sizes

COLOUR 1



ZOMBIE
GLOSS

POISON
GLOSS

THE MAN IN BLACK
GLOSS

COLOUR 2



NEVERMIND
GLOSS

THE MAN IN BLACK
GLOSS

BRASS MONKEY
GLOSS

Frame	Rocky Mountain 6061 Alloy. Threaded BB. Zero Stack Tapered Headtube
Fork	Suntour XCR32 LOR Air 100mm
F / Brake	Shimano MT201
R / Brake	Shimano MT201
F / Rotor	Shimano RT10 160mm
R / Rotor	Shimano RT10 160mm
R / Shifter	Shimano Altus
R / Derailleur	Shimano Altus
Crankset	Rocky Mountain Microdrive 2PC 28T
Chainguide	Micro Chainguide
Bottom Bracket	Rocky Mountain Sealed - Shimano Compatible
Pedals	Alloy Platform
Cassette	SunRace CSM980 11-40T
Chain	KMC X9
F / Hub	Shimano TX505
R / Hub	Shimano TX505
Spokes	2.0 Stainless
F / Rim	WTB ST i30 TCS 2.0 Tubeless
R / Rim	WTB ST i30 TCS 2.0 Tubeless
F / Tire	WTB Ranger Comp 29 x 2.4
R / Tire	WTB Ranger Comp 29 x 2.4
Headset	FSA No. 57B-1
Stem	Rocky Mountain XC
Handlebar	Rocky Mountain XC 760mm
Grips / Tape	Rocky Mountain Lock On Light
Seatpost	Rocky Mountain 27.2mm
Saddle	WTB Volt 142

B0046

MSRP

Fusion 10

MODEL HIGHLIGHTS

- Stable, easy going geometry & fit
- Vertex quickness with extra stability
- Lightweight alloy frame
- Simple & reliable 1x drivetrain

IMPROVEMENTS OVER PREVIOUS MODEL

- Chain guide for reliable chain retention
- Wider saddles for comfort
- Size specific grips - thicker diameter for bigger sizes

COLOUR 1



FOLSOM PRISON BLUE
GLOSS

THE MAN IN BLACK
GLOSS

BILLY OCEAN
GLOSS

COLOUR 2



FLAMING LIPS
GLOSS

THE MAN IN BLACK
GLOSS

SUNDAY BLOODY SUNDAY
GLOSS

Frame	Rocky Mountain 6061 Alloy. Threaded BB. Zero Stack Tapered Headtube
Fork	Suntour XCM 100mm
F / Brake	Shimano MT200
R / Brake	Shimano MT200
F / Rotor	Shimano RT10 160mm
R / Rotor	Shimano RT10 160mm
R / Shifter	Shimano Altus
R / Derailleur	Shimano Altus
Crankset	Rocky Mountain Microdrive 28T
Chainguide	Micro Chainguide
Bottom Bracket	FSA Sealed Cartridge Bearing
Pedals	Nylon Platform
Cassette	SunRace CSM680 11-40T
Chain	KMC Z8.3
F / Hub	Shimano TX505
R / Hub	Shimano TX505
Spokes	2.0 Stainless
F / Rim	WTB SX19
R / Rim	WTB SX19
F / Tire	WTB Ranger Comp 29 x 2.25
R / Tire	WTB Ranger Comp 29 x 2.25
Headset	FSA No. 57B-1
Stem	Rocky Mountain XC
Handlebar	Rocky Mountain XC 740mm
Grips / Tape	Rocky Mountain Lock On Light
Seatpost	Rocky Mountain 27.2mm
Saddle	WTB Volt 142

GROWLER

DESIGNED FOR

Trail

FRONT TRAVEL

130 & 140 MM

WHEEL SIZE

29" Wide Trail

NEW FOR 2020!

Like a fresh fill of a West Coast IPA, the Growler packs a punch of confidence with its 29x2.6 tires. Cheers, eh!

Push those pedals, hold the line, and enjoy what feels like infinite traction across rough terrain. The Growler is an incredibly capable hardtail that makes short work out of technical climbs, is ready to rail corners, and smooth out uneven ground.

FRAME TECHNOLOGY



RMB 6061
ALLOY

NOTES

Rider:
Erik Lawrenuk

Photo:
Margus Riga

Location:
Whistler, BC



GROWLER

GEOMETRY

- HTA** Head Tube Angle (deg)
- STA** Seat Tube Angle (deg)
- STL** Seat Tube Length (mm)
- TTH** Top Tube Horizontal (mm)
- HTL** Head Tube Length (mm)
- RC** Rear Centre (mm)
- BBD** Bottom Bracket Drop (mm)
- SH** Standover Height (mm)
- WB** Wheelbase (mm)
- R** Reach (mm)
- S** Stack (mm)

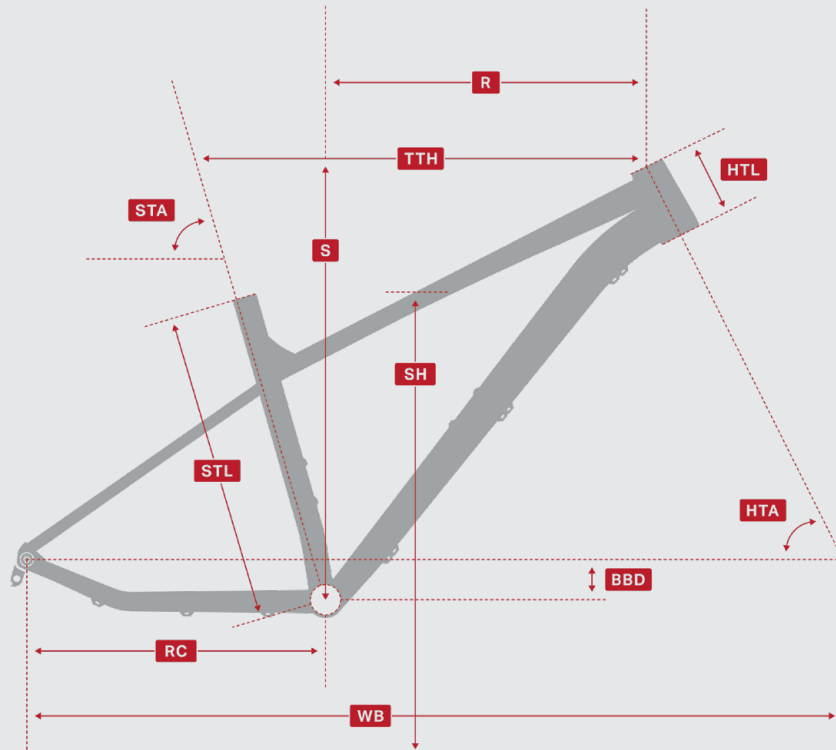

29" Wide Trail

	SM	MD	LG	XL
HTA	64°	64°	64°	64°
STA	75°	75°	75°	75°
STL	380	420	445	480
TTH	586	610	638	670
HTL	95	100	110	120
RC	435	435	435	435
BBD	55	55	55	55
SH	780	793	802	815
WB	1182	1208	1237	1271
R	422	445	470	500
S	613	618	627	636

GROWLER COLOURWAYS

Growler 50

COLOUR 1



BROWN SUGAR
GLOSS

THE MAN IN BLACK
GLOSS

BRASS MONKEY
GLOSS

Rider:
Erik Lawrenuk

Photo:
Margus Riga

Location:
Whistler, BC



GROWLER COLOURWAYS

Growler 40

COLOUR 1



SUNDAY BLOODY SUNDAY
GLOSS

THE MAN IN BLACK
GLOSS

HAZZARD
GLOSS

Growler 40

COLOUR 2



NEVERMIND
GLOSS

THE MAN IN BLACK
GLOSS

FOLSOM PRISON BLUE
GLOSS

GROWLER COLOURWAYS

Growler 20

COLOUR 1



RUSTY CAGE
GLOSS

THE MAN IN BLACK
GLOSS

YELLOW SUBMARINE
GLOSS

Growler 20

COLOUR 2



TOUCH OF GREY
GLOSS

THE MAN IN BLACK
GLOSS

B0041

MSRP

Growler 50

MODEL HIGHLIGHTS

- Aggressive & progressive geometry
- Designed around 29x2.6" tires
- Boost 148mm rear hub
- Full internal cables
- Slayer fit & feel, in a hardtail

COLOUR 1



BROWN SUGAR
GLOSS

THE MAN IN BLACK
GLOSS

BRASS MONKEY
GLOSS

Frame	Rocky Mountain 6061 Alloy. Threaded BB. Boost 148mm. Tapered Zerostack Headtube. Dropper Post Compatible.
Fork	RockShox 35 Gold RL 140mm 44mm Offset
F / Brake	Shimano MT420 4 Piston
R / Brake	Shimano MT400
F / Rotor	Shimano RT30 180mm
R / Rotor	Shimano RT30 180mm
R / Shifter	Sram NX Eagle
R / Derailleur	Sram GX Eagle
Crankset	Sram SX Eagle 30T
Bottom Bracket	Sram BSA DUB
Pedals	Alloy Platform
Cassette	Sram PG-1210 11-50T
Chain	Sram SX Eagle
F / Hub	Shimano MT400 Boost 15mm
R / Hub	Shimano MT400 Boost 148mm
Spokes	2.0 Stainless
F / Rim	WTB ST i30 TCS 2.0 Tubeless
R / Rim	WTB ST i30 TCS 2.0 Tubeless
F / Rim Tape	Tubeless Ready - Tape / Valves Incl.
R / Rim Tape	Tubeless Ready - Tape / Valves Incl.
F / Tire	WTB Vigilante TCS Light High Grip Tri-Tec 29 x 2.6
R / Tire	WTB TrailBoss G2 TCS Light Fast Rolling Tri-Tec 29 x 2.6
Headset	FSA Orbit NO.57E
Stem	Rocky Mountain 35 AM
Handlebar	Rocky Mountain AM 780mm
Grips / Tape	Rocky Mountain Lock On Light
Seatpost	Rocky Mountain Toonie Drop 30.9mm
Saddle	WTB Volt Race 142

B0042

MSRP

Growler 40

MODEL HIGHLIGHTS

- Aggressive & progressive geometry
- Designed around 29x2.6" tires
- Boost 148mm rear hub
- Full internal cables
- Slayer fit & feel, in a hardtail

COLOUR 1



SUNDAY BLOODY SUNDAY
GLOSS

THE MAN IN BLACK
GLOSS

HAZZARD
GLOSS

COLOUR 2



NEVERMIND
GLOSS

THE MAN IN BLACK
GLOSS

FOLSOM PRISON BLUE
GLOSS

Frame	Rocky Mountain 6061 Alloy. Threaded BB. Boost 148mm. Tapered Zerostack Headtube. Dropper Post Compatible.
Fork	Suntour Raidon 34 LOR Air Boost 130mm
F / Brake	Shimano MT400
R / Brake	Shimano MT400
F / Rotor	Shimano RT30 180mm
R / Rotor	Shimano RT30 180mm
R / Shifter	Sram SX Eagle
R / Derailleur	Sram SX Eagle
Crankset	Sram SX Eagle Powerspline 30T
Bottom Bracket	Sram Powerspline
Pedals	Alloy Platform
Cassette	Sram PG-1210 11-50T
Chain	Sram SX Eagle
F / Hub	Shimano MT400 Boost 15mm
R / Hub	Shimano MT400 Boost 148mm
Spokes	2.0 Stainless
F / Rim	WTB ST i30 TCS 2.0 Tubeless
R / Rim	WTB ST i30 TCS 2.0 Tubeless
F / Rim Tape	Tubeless Ready - Tape / Valves Incl.
R / Rim Tape	Tubeless Ready - Tape / Valves Incl.
F / Tire	WTB Vigilante TCS Light High Grip Tri-Tec 29 x 2.6
R / Tire	WTB TrailBoss G2 TCS Light Fast Rolling Tri-Tec 29 x 2.6
Headset	FSA No. 57B
Stem	Rocky Mountain XC
Handlebar	Rocky Mountain AM 780mm
Grips / Tape	Rocky Mountain Lock On Light
Seatpost	Rocky Mountain Toonie Drop 30.9mm
Saddle	WTB Volt 142

B0043

MSRP

Growler 20

MODEL HIGHLIGHTS

- Aggressive & progressive geometry
- Designed around 29x2.6" tires
- Boost 148mm rear hub
- Full internal cables
- Slayer fit & feel, in a hardtail

COLOUR 1



RUSTY CAGE
GLOSS

THE MAN IN BLACK
GLOSS

YELLOW SUBMARINE
GLOSS

COLOUR 2



TOUCH OF GREY
GLOSS

THE MAN IN BLACK
GLOSS

Frame	Rocky Mountain 6061 Alloy. Threaded BB. Boost 148mm. Tapered Zerostack Headtube. Dropper Post Compatible.
Fork	Suntour XCM34 DS 130mm
F / Brake	Shimano MT201
R / Brake	Shimano MT201
F / Rotor	Shimano RT10 180mm
R / Rotor	Shimano RT10 180mm
R / Shifter	Shimano Altus
R / Derailleur	Shimano Altus
Crankset	Rocky Mountain Microdrive 28T
Chainguide	Micro Chainguide
Bottom Bracket	FSA Sealed Cartridge Bearing
Pedals	Alloy Platform
Cassette	SunRace CSM980 11-40T
Chain	KMC X9
F / Hub	Shimano MT400 Boost 15mm
R / Hub	Shimano MT400 Boost 148mm
Spokes	2.0 Stainless
F / Rim	WTB ST i30 TCS 2.0 Tubeless
R / Rim	WTB ST i30 TCS 2.0 Tubeless
F / Tire	WTB Trail Boss G2 29 x 2.6
R / Tire	WTB Trail Boss G2 29 x 2.6
Headset	FSA No. 57B
Stem	Rocky Mountain XC
Handlebar	Rocky Mountain AM 780mm
Grips / Tape	Rocky Mountain Lock On Light
Seatpost	Rocky Mountain 30.9mm
Saddle	WTB Volt 142

SOUL

DESIGNED FOR
Sport Trail

FRONT TRAVEL
120 MM

WHEEL SIZE
27.5"

NEW FOR 2020!

Ready for camping trips with the family and the gravel paths of your neighbourhood. If you're going to ride, ride in style.

Take that shortcut through the park, not because it's faster but because it's fun. The Soul comes equipped with front suspension, disc brakes, 1x drivetrain, and knobby tires for a smooth and comfortable ride.

FRAME TECHNOLOGY



RMB 6061
ALLOY

NOTES

Rider:
MJ Guindon

Photo:
Margus Riga

Location:
Vancouver, BC



SOUL

GEOMETRY

- HTA** *Head Tube Angle (deg)*
- STA** *Seat Tube Angle (deg)*
- STL** *Seat Tube Length (mm)*
- TTH** *Top Tube Horizontal (mm)*
- HTL** *Head Tube Length (mm)*
- RC** *Rear Centre (mm)*
- BBD** *Bottom Bracket Drop (mm)*
- SH** *Standover Height (mm)*
- WB** *Wheelbase (mm)*
- R** *Reach (mm)*
- S** *Stack (mm)*

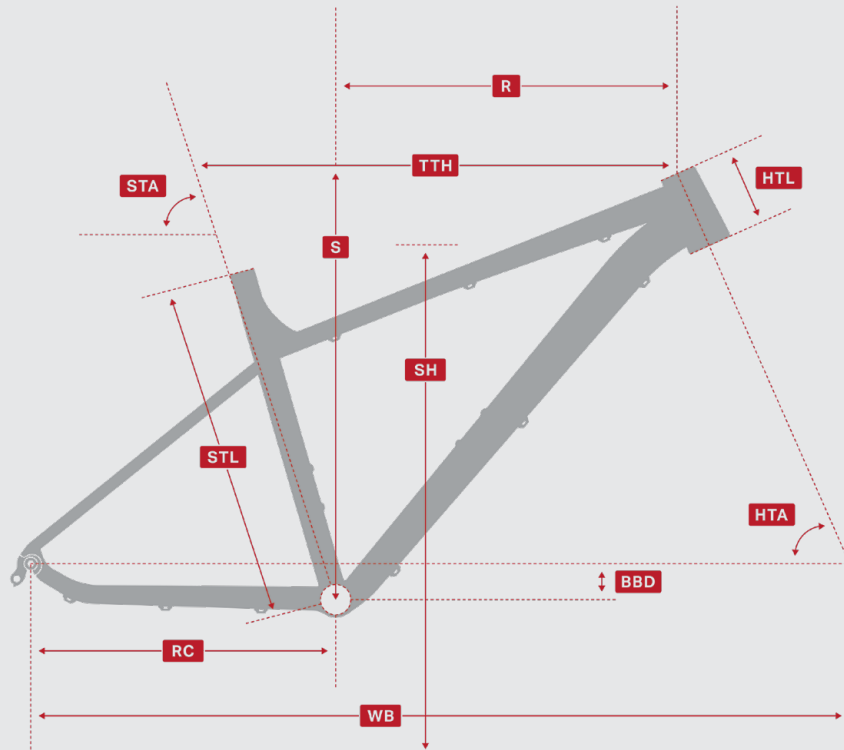

	XS	SM	MD	LG
HTA	66°	66°	66°	66°
STA	74°	74°	74°	74°
STL	352	392	432	470
TTH	555	583	612	644
HTL	95	95	100	110
RC	425	425	425	425
BBD	48	48	48	48
SH	747	754	766	781
WB	1096	1124	1153	1187
R	389	417	445	474
S	578	579	583	592

SOUL COLOURWAYS

Soul 20

COLOUR 1



SPACE ODDITY
MATTE

BACK IN BLACK
MATTE

BRASS MONKEY
MATTE

Rider:
MJ Guindon

Photo:
Margus Riga

Location:
Vancouver, BC



Image for colour and graphic reference only. Please refer to specification table.

SOUL COLOURWAYS

Soul 10

COLOUR 1



POISON
GLOSS

THE MAN IN BLACK
GLOSS

BILLY OCEAN
GLOSS

Soul 10

COLOUR 2



TOUCH OF GREY
MATTE

BACK IN BLACK
MATTE

NEVERMIND
MATTE

B0047

MSRP

Soul 20

MODEL HIGHLIGHTS

- True trail geometry & handling at an affordable price
- Lightweight alloy frame
- Simple & reliable 1x drivetrain

IMPROVEMENTS OVER PREVIOUS MODEL

- Longer, lower & slacker
- 34mm stanchion 120mm travel fork
- Chain guide for reliable chain retention
- Wider rims & tires for grip & control
- Wider bars for control

COLOUR 1



SPACE ODDITY
MATTE

BACK IN BLACK
MATTE

BRASS MONKEY
MATTE

Frame	Rocky Mountain 6061 Alloy. Threaded BB. Zero Stack Tapered Headtube. Dropper Post Compatible.
Fork	Suntour XCM34 Boost 120mm
F / Brake	Shimano MT201
R / Brake	Shimano MT201
F / Rotor	Shimano RT10 160mm
R / Rotor	Shimano RT10 160mm
R / Shifter	Shimano Altus
R / Derailleur	Shimano Altus
Crankset	Rocky Mountain Microdrive 28T
Chainguide	Micro Chainguide
Bottom Bracket	FSA Sealed Cartridge Bearing
Pedals	Alloy Platform
Cassette	SunRace CSM980 11-40T
Chain	KMC X9
F / Hub	Shimano MT400 Boost 15mm
R / Hub	Shimano TX505
Spokes	2.0 Stainless
F / Rim	WTB ST i25 TCS Tubeless
R / Rim	WTB ST i25 TCS Tubeless
F / Tire	WTB Vigilante Comp 27.5 x 2.3
R / Tire	WTB Ranger Comp 27.5 x 2.25
Headset	FSA No. 57B
Stem	Rocky Mountain XC
Handlebar	Rocky Mountain AM 780mm
Grips / Tape	Rocky Mountain Lock On Light
Seatpost	Rocky Mountain 30.9mm
Saddle	WTB Volt 142

B0048

MSRP

Soul 10

MODEL HIGHLIGHTS

- True trail geometry & handling at an affordable price
- Lightweight alloy frame
- Simple & reliable 1x drivetrain

IMPROVEMENTS OVER PREVIOUS MODEL

- Longer, lower & slacker
- Chain guide for reliable chain retention
- Wider rims & tires for grip & control

COLOUR 1



POISON
GLOSS

THE MAN IN BLACK
GLOSS

BILLY OCEAN
GLOSS

COLOUR 2



TOUCH OF GREY
MATTE

BACK IN BLACK
MATTE

NEVERMIND
MATTE

Frame	Rocky Mountain 6061 Alloy. Threaded BB. Zero Stack Tapered Headtube. Dropper Post Compatible.
Fork	Suntour XCM DS 120mm
F / Brake	Shimano MT200
R / Brake	Shimano MT200
F / Rotor	Shimano RT10 160mm
R / Rotor	Shimano RT10 160mm
R / Shifter	Shimano Altus
R / Derailleur	Shimano Altus
Crankset	Rocky Mountain Microdrive 28T
Chainguide	Micro Chainguide
Bottom Bracket	FSA Sealed Cartridge Bearing
Pedals	Nylon Platform
Cassette	SunRace CSM680 11-40T
Chain	KMC Z8.3
F / Hub	Shimano TX505
R / Hub	Shimano TX505
Spokes	2.0 Stainless
F / Rim	WTB ST i23 TCS Tubeless
R / Rim	WTB ST i23 TCS Tubeless
F / Tire	WTB Vigilante Comp 27.5 x 2.3
R / Tire	WTB Ranger Comp 27.5 x 2.25
Headset	FSA No. 57B-1
Stem	Rocky Mountain XC
Handlebar	Rocky Mountain XC 740mm
Grips / Tape	Rocky Mountain Lock On Light
Seatpost	Rocky Mountain 30.9mm
Saddle	WTB Volt 142

SOLO

DESIGNED FOR
Adventure

WHEEL SIZE
700c & 650b

Built for the pursuit of adventure, the Solo doesn't stop when the pavement ends.

From your familiar weekly rides to taking a chance off the beaten path, the Solo is a bike for any adventure. With massive tire clearance, the ability to run a full-length dropper post, and a 1x specific frame, it's designed for riding anywhere and everywhere. Start your adventure and make every ride your own.

FRAME TECHNOLOGY



RMB 6061
ALLOY

NOTES

Rider:
Sam Schultz

Photo:
Margus Riga

Location:
Arizona, USA



SOLO

GEOMETRY

HTA	Head Tube Angle (deg)
STA	Seat Tube Angle (deg)
STL	Seat Tube Length (mm)
TTH	Top Tube Horizontal (mm)
HTL	Head Tube Length (mm)
RC	Rear Centre (mm)
BBD	Bottom Bracket Drop (mm)
SH	Standover Height (mm)
WB	Wheelbase (mm)
R	Reach (mm)
S	Stack (mm)

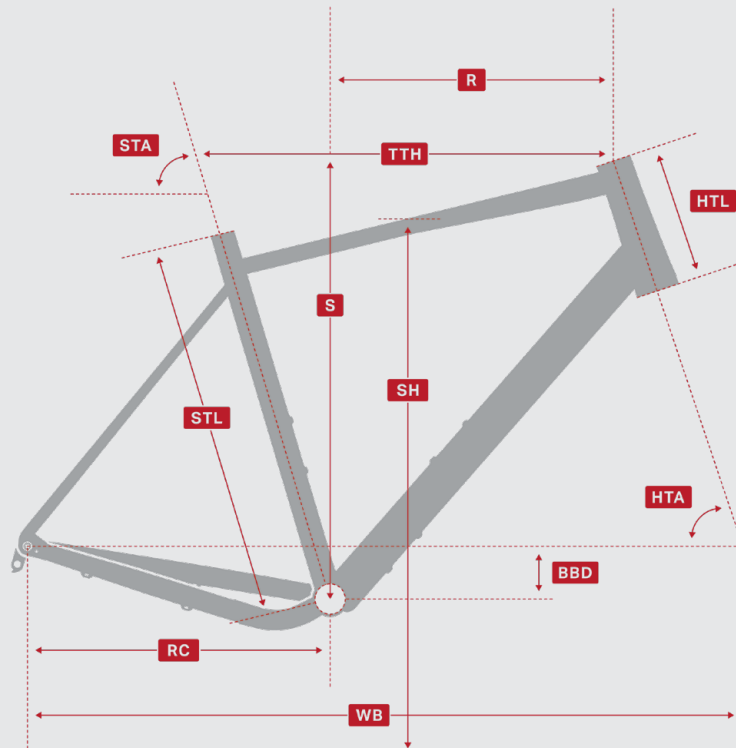

	XS	SM	MD	LG	XL
HTA	69.5°	70°	71°	71°	72°
STA	75°	74.5°	74°	73.5°	73°
STL	414	452	490	528	566
TTH	520	540	560	580	605
HTL	110	135	160	195	220
RC	425	425	425	425	425
BBD	70	70	70	70	70
SH	742	771	800	836	866
WB	1022	1035	1041	1057	1066
R	384	392	399	404	414
S	527	553	580	613	641

SOLO COLOURWAYS

Solo 50

COLOUR 1



BROWN SUGAR
GLOSS

THE MAN IN BLACK
GLOSS

HAZZARD
GLOSS

Solo 30

COLOUR 1



FOLSOM PRISON BLUE
GLOSS

THE MAN IN BLACK
GLOSS

BRASS MONKEY
GLOSS

B0062

MSRP

Solo 50

MODEL HIGHLIGHTS

- Multi faceted gravel / adventure bike
- Stable, fun handling
- Up to 5 water bottle mounts, depending on size
- Wide range 1x drivetrain for simplicity
- Dropper post compatible

IMPROVEMENTS OVER PREVIOUS MODEL

- Faster rolling tires

COLOUR 1



BROWN SUGAR
GLOSS

THE MAN IN BLACK
GLOSS

HAZZARD
GLOSS

Frame	Rocky Mountain Butted 6061 SL Series Alloy. 1x Only. BB386 EVO. 12x142mm Axle. Flat Mount Disc. 700x40c & 650bx2.2 Compatible. Dropper Post Compatible. Fender Mounts
Fork	Rocky Mountain Carbon Gravel. 15mm Axle. Cargo 3 Pack & Fender Mounts
F / Brake	Sram Apex 1 Disc
R / Brake	Sram Apex 1 Disc
F / Rotor	Sram Centerline 160mm
R / Rotor	Sram Centerline 160mm
R / Shifter	Sram Apex
R / Derailleur	Sram Apex 1
Crankset	Sram Apex 42T
Bottom Bracket	Rocky Mountain BB386 24mm Axle
Cassette	Sram XG-1150 10-42T
Chain	KMC X11-1
F / Hub	Rocky Mountain Sealed 15mm
R / Hub	Sram MTH 746 142mm
Spokes	WTB 2.0
F / Rim	WTB ST i21 TCS Tubeless
R / Rim	WTB ST i21 TCS Tubeless
F / Rim Tape	Tubeless Ready - Tape / Valves Incl.
R / Rim Tape	Tubeless Ready - Tape / Valves Incl.
F / Tire	WTB Venture TCS Light Fast Rolling 700 x 40c
R / Tire	WTB Venture TCS Light Fast Rolling 700 x 40c
Headset	FSA Orbit NO.57E
Stem	Rocky Mountain XC
Handlebar	Rocky Mountain Flare Drop
Grips / Tape	Rocky Mountain Gel Bar Tape
Seatpost	Rocky Mountain 30.9mm
Saddle	WTB Volt Race 142

B0063

MSRP

Solo 30

MODEL HIGHLIGHTS

- Multi faceted gravel / adventure bike
- Stable, fun handling
- Up to 5 water bottle mounts, depending on size
- Wide range 1x drivetrain for simplicity
- Dropper post compatible

IMPROVEMENTS OVER PREVIOUS MODEL

- Faster rolling tires

COLOUR 1



FOLSOM PRISON BLUE
GLOSS

THE MAN IN BLACK
GLOSS

BRASS MONKEY
GLOSS

Frame	Rocky Mountain Butted 6061 SL Series Alloy. 1x Only. BB386 EVO. 12x142mm Axle. Flat Mount Disc. 700x40c & 650bx2.2 Compatible. Dropper Post Compatible. Fender Mounts
Fork	Rocky Mountain Carbon Gravel. 15mm Axle. Cargo 3 Pack & Fender Mounts
F / Brake	TRP Spyre
R / Brake	TRP Spyre
F / Rotor	TRP 160mm
R / Rotor	TRP 160mm
R / Shifter	Sram Apex
R / Derailleur	Sram Apex 1
Crankset	Sram Apex 42T
Bottom Bracket	Rocky Mountain BB386 24mm Axle
Cassette	Sram PG-1130 11-42T
Chain	KMC X11-1
F / Hub	Rocky Mountain Sealed 15mm
R / Hub	Rocky Mountain 12x142mm
Spokes	WTB 2.0
F / Rim	WTB ST i21 TCS Tubeless
R / Rim	WTB ST i21 TCS Tubeless
F / Rim Tape	Tubeless Ready - Tape / Valves Incl.
R / Rim Tape	Tubeless Ready - Tape / Valves Incl.
F / Tire	WTB Venture TCS Light Fast Rolling 700 x 40c
R / Tire	WTB Venture TCS Light Fast Rolling 700 x 40c
Headset	FSA Orbit NO.57E
Stem	Rocky Mountain XC
Handlebar	Rocky Mountain Flare Drop
Grips / Tape	Rocky Mountain Gel Bar Tape
Seatpost	Rocky Mountain 30.9mm
Saddle	WTB Volt 142

Whether they're riding to school or are putting their first tracks on dirt, experiencing the thrill of riding a bike is a fundamental and healthy part of growing up. Starting with toddler-friendly run bikes, our youth bike lineup has kids covered for any adventure.

Youth

A young rider wearing a blue and white helmet and dark clothing is performing a wheelie on a mountain bike. The bike is in the air, with the front wheel touching the ground. The background is a dirt trail with trees and a bright sky, creating a warm, golden light. The word "Youth" is overlaid in large white text.

Rider:
Dane Jewett

Photo:
Margus Riga

Location:
Whistler, BC

REAPER

DESIGNED FOR
Youth trail

FRONT TRAVEL
120 & 130 MM

REAR TRAVEL
130 MM

WHEEL SIZE
24, 26, & 27.5"*

The Reaper packs the same aggressive trail performance found in our full suspension bikes like the Altitude and Instinct, but in a smaller package for young rippers. Don't fear the Reaper.

The Reaper can tear up singletrack, smash technical descents, and slay bike park laps all day long. And, because we know that kids grow (and have younger siblings), the Reaper is easily convertible from 24" wheels to 26" wheels and vice versa. We also have the Reaper 27.5 option, to keep your kids shredding longer!

**Reaper 27.5 is 26+ compatible.*

NOTES

Rider:
Dane Jewett

Photo:
Margus Riga

Location:
Whistler, BC

FRAME TECHNOLOGY

 **FORM Alloy**
FRAME MATERIAL

 **RIDE-9**
ADJUSTMENT SYSTEM

 **Smoothlink**
SUSPENSION

 **Size Specific**
TUNE



REAPER

GEOMETRY

Geometry shown for Slack, Neutral, and Steep RIDE-9™ positions.

- HTA** Head Tube Angle (deg)
- STA** Seat Tube Angle (deg)
- STL** Seat Tube Length (mm)
- TTH** Top Tube Horizontal (mm)
- HTL** Head Tube Length (mm)
- RC** Rear Centre (mm)
- BBD** Bottom Bracket Drop (mm)
- SH** Standover Height (mm)
- WB** Wheelbase (mm)
- R** Reach (mm)
- S** Stack (mm)

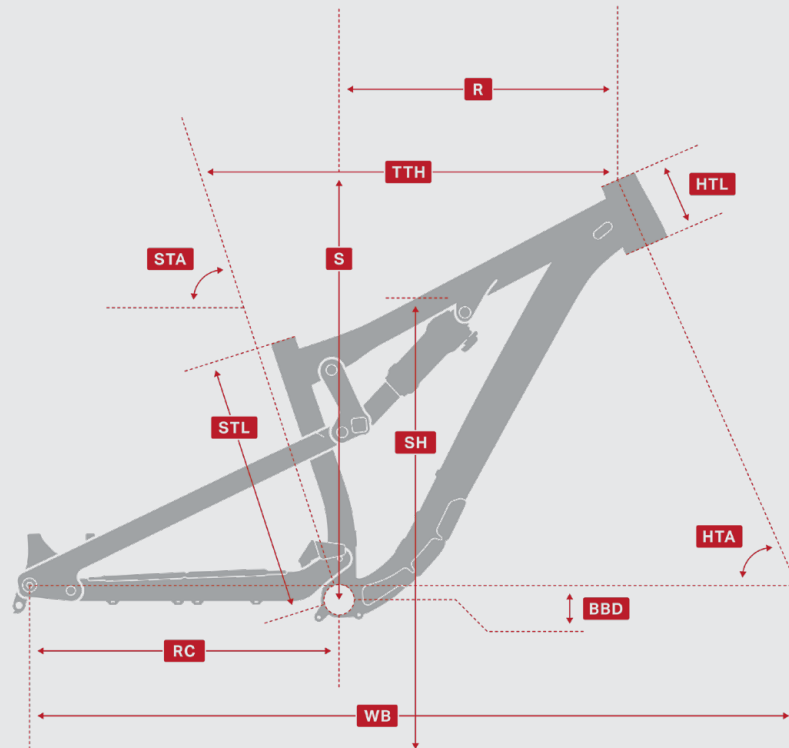

	27.5"			26"			24"		
	Slack	Neutral	Steep	Slack	Neutral	Steep	Slack	Neutral	Steep
HTA	66.4°	67°	67.6°	63.9°	64.6°	65.3°	65.3°	66°	66.8°
STA	74.4°	75°	75.6°	73.4°	74.1°	74.8°	74.8°	75.5°	76.3°
STL	356	356	356	331	331	331	331	331	331
TTH	547	545	544	504	503	501	501	499	497
HTL	100	100	100	93	93	93	93	93	93
RC	426	425	424	420	418	417	419	418	417
BBD	28	21	413	14	6	-3	24	16	8
SH	792	795	797	727	729	730	692	694	695
WB	1100	1099	1098	1072	1071	1069	1054	1053	1052
R	385	391	397	340	347	354	353	360	367
S	580	576	572	551	547	542	542.7	538	533

REAPER COLOURWAYS

Reaper 27.5

COLOUR 1



BROWN SUGAR
GLOSS

BACK IN BLACK
GLOSS

SURFIN' BIRD
GLOSS

Reaper 26

COLOUR 1



SURFIN' BIRD
GLOSS

BACK IN BLACK
GLOSS

SCHOOL'S OUT
GLOSS

REAPER COLOURWAYS

Reaper 24

COLOUR 1



HAZZARD
GLOSS

BACK IN BLACK
GLOSS

BILLY OCEAN
GLOSS

Rider:
Dane Jewett

Photo:
Margus Riga

Location:
Whistler, BC



B0038

MSRP

Reaper 27.5

MODEL HIGHLIGHTS

- High performance trail bike for young riders
- Wide range gearing
- High performance tires
- RIDE-9 Geometry adjustment tailors bike to suit the rider & terrain
- Compatible with 26" x 2.8 wheels

IMPROVEMENTS OVER PREVIOUS MODEL

- Short offset fork for stability
- Wide range Eagle drivetrain
- Wider rims for control

COLOUR 1



BROWN SUGAR
GLOSS

BACK IN BLACK
GLOSS

SURFIN' BIRD
GLOSS

Front Triangle	FORM Alloy. Full Sealed Cartridge Bearings. Press Fit BB. Internal Cable Routing. 2-Bolt ISCG05 Tabs. RIDE-9 Adjustable Geometry + Suspension Rate. 140mm Travel.
Chainstay	FORM Alloy
Seatstay	FORM Alloy
Fork	RockShox Sektor RL 130mm 37mm Offset
Rear Shock	RockShox Deluxe Select+ RT
F / Brake	Shimano M6000
R / Brake	Shimano M6000
F / Rotor	Shimano RT64 180mm
R / Rotor	Shimano RT64 180mm
R / Shifter	Sram SX Eagle
R / Derailleur	Sram SX Eagle
Crankset	Sram SX Eagle 30T
Bottom Bracket	Sram BB92 DUB
Cassette	Sram PG-1210 11-50T
Chain	Sram SX Eagle
F / Hub	Shimano MT400 Boost 15mm
R / Hub	Shimano MT400 Boost 148mm
Spokes	2.0 Stainless
F / Rim	WTB ST i23 TCS Tubeless
R / Rim	WTB ST i23 TCS Tubeless
F / Tire	Maxxis Minion DHR II Folding 27.5 x 2.3
R / Tire	Maxxis Minion DHR II Folding 27.5 x 2.3
Headset	FSA Orbit NO.57E
Stem	Rocky Mountain AM
Handlebar	Rocky Mountain AM 760mm
Grips / Tape	Rocky Mountain Lock On Light
Seatpost	Rocky Mountain Toonie Drop 30.9mm x 100mm Drop
Saddle	WTB Volt Race 142

B0039

MSRP

Reaper 26

MODEL HIGHLIGHTS

- High performance trail bike for young riders
- Can convert to 24" wheels
- Air sprung suspension tuned for lightweight riders
- High performance tires
- RIDE-9 Geometry adjustment tailors bike to suit the rider & terrain

COLOUR 1



SURFIN' BIRD
GLOSS

BACK IN BLACK
GLOSS

SCHOOL'S OUT
GLOSS

Front Triangle	FORM Alloy. Full Sealed Cartridge Bearings. Press Fit BB. Internal Cable Routing. 2-Bolt ISCG05 Tabs. RIDE-9 Adjustable Geometry + Suspension Rate. 130mm Travel.
Chainstay	FORM Alloy
Seatstay	FORM Alloy
Fork	RockShox Sektor RL 130mm 37mm Offset
Rear Shock	RockShox Monarch R
F / Brake	Shimano MT400
R / Brake	Shimano MT400
F / Rotor	Shimano RT30 160mm
R / Rotor	Shimano RT30 160mm
R / Shifter	Shimano Deore
R / Derailleur	Shimano Deore
Crankset	Race Face Ride Cinch 30T Steel
Bottom Bracket	Shimano SM-BBMT500
Cassette	Shimano HG-500 11-42T
Chain	KMC X10-1
F / Hub	Shimano MT400 Boost 15mm
R / Hub	Shimano MT400 Boost 148mm
Spokes	2.0 Stainless
F / Rim	WTB ST i21 TCS Tubeless
R / Rim	WTB ST i21 TCS Tubeless
F / Tire	Maxxis Minion DHF Folding 26 x 2.35
R / Tire	Maxxis Minion DHF Folding 26 x 2.35
Headset	FSA No. 57B
Stem	Rocky Mountain AM
Handlebar	Rocky Mountain AM 720mm
Grips / Tape	Rocky Mountain Lock On Light
Seatpost	Rocky Mountain Toonie Drop 30.9mm x 80mm Drop
Saddle	WTB Volt Race 142

B0040

MSRP

Reaper 24

MODEL HIGHLIGHTS

- High performance trail bike for young riders
- Can convert to 26" wheels
- Air sprung suspension tuned for lightweight riders
- High performance tires
- RIDE-9 Geometry adjustment tailors bike to suit the rider & terrain

COLOUR 1



HAZZARD
GLOSS

BACK IN BLACK
GLOSS

BILLY OCEAN
GLOSS

Front Triangle	FORM Alloy. Full Sealed Cartridge Bearings. Press Fit BB. Internal Cable Routing. 2-Bolt ISCG05 Tabs. RIDE-9 Adjustable Geometry + Suspension Rate. 130mm Travel.
Chainstay	FORM Alloy
Seatstay	FORM Alloy
Fork	Suntour Raidon 32 LOR DS 120mm
Rear Shock	RockShox Monarch R
F / Brake	Shimano MT200
R / Brake	Shimano MT200
F / Rotor	Shimano RT30 160mm
R / Rotor	Shimano RT30 160mm
R / Shifter	Shimano Deore
R / Derailleur	Shimano Deore
Crankset	Rocky Mountain Microdrive 2PC 28T
Bottom Bracket	Rocky Mountain Sealed BB92 - Shimano Compatible
Cassette	Shimano HG-500 11-42T
Chain	KMC X10-1
F / Hub	Shimano M6010 15mm
R / Hub	Shimano MT400 Boost 148mm
Spokes	2.0 Stainless
F / Rim	WTB SX17
R / Rim	WTB SX17
F / Tire	VeeTire Crown GEM 24x2.25
R / Tire	VeeTire Crown GEM 24x2.25
Headset	FSA No. 57B-1
Stem	Rocky Mountain AM
Handlebar	Rocky Mountain AM 720mm
Grips / Tape	Rocky Mountain Lock On Light
Seatpost	Rocky Mountain SL 30.9mm
Saddle	Rocky Mountain Kids

GROWLER JR

DESIGNED FOR
Youth Trail

FRONT TRAVEL
80 & 100 MM

WHEEL SIZE
24+ & 26+

JR 24 NEW FOR 2020!

Not your typical "big wheel", the Growler Jr comes ready with everything you need to hit the trails.

From hucking off curbs, skidding in alleyways, and riding your first sections of singletrack, the Growler Jr is ready to tackle it all. The Growler Jr comes complete with a 1x drivetrain to keep things simple, and 26+ or 24+ tires are there to help smooth out the bumps. Shred it hard and have some fun!

NOTES

FRAME TECHNOLOGY



RMB 6061
ALLOY

Riders:
Jakob & Dane Jewett, Geoff Gulevich

Photo:
Paris Gore

Location:
North Vancouver, BC



GROWLER JR

GEOMETRY

- HTA** Head Tube Angle (deg)
- STA** Seat Tube Angle (deg)
- STL** Seat Tube Length (mm)
- TTH** Top Tube Horizontal (mm)
- HTL** Head Tube Length (mm)
- RC** Rear Centre (mm)
- BBD** Bottom Bracket Drop (mm)
- SH** Standover Height (mm)
- WB** Wheelbase (mm)
- R** Reach (mm)
- S** Stack (mm)

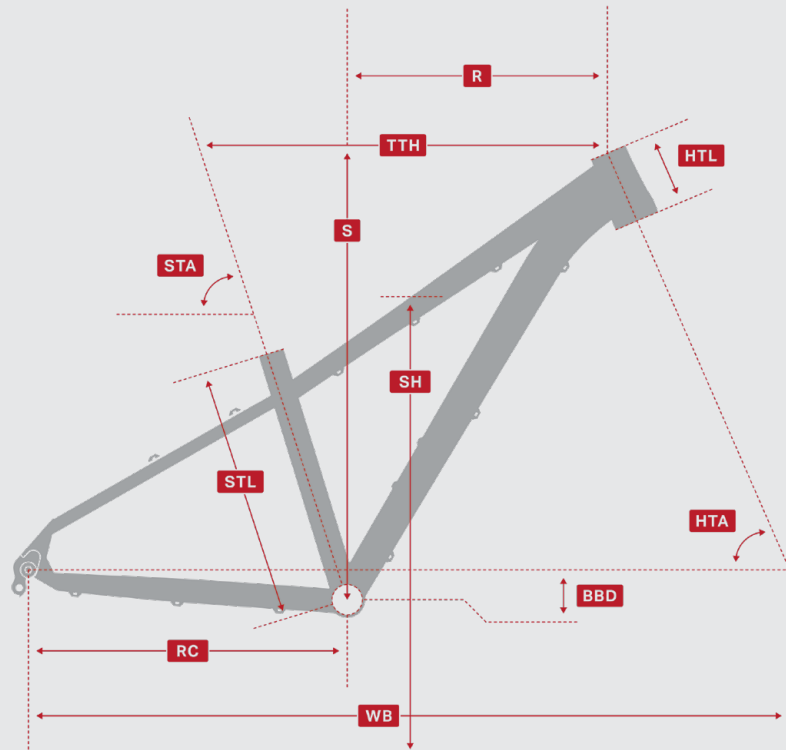

Growler Jr 26

Growler Jr 24

14"

12"

HTA	66°	66°
STA	73°	73°
STL	335	300
TTH	540	520
HTL	90	80
RC	425	410
BBD	40	40
SH	767	695
WB	1074	1026
R	366	361
S	577	519

GROWLER JR COLOURWAYS

Growler Jr 26

COLOUR 1



VOLCANO
GLOSS

BACK IN BLACK
GLOSS

POISON
GLOSS

Growler Jr 24

COLOUR 1



NEVERMIND
MATTE

BACK IN BLACK
MATTE

YELLOW SUBMARINE
MATTE

B0059

MSRP

Growler Jr 26

MODEL HIGHLIGHTS

- Rocky Mountain trail performance for young riders
- Big tires for grip and control
- Enough travel to keep you out of trouble & tame bounce
- Simple 1x drivetrain

IMPROVEMENTS OVER PREVIOUS MODEL

- Slacker, shorter rear end
- Shorter travel fork to lower standover
- Chainguide for reliable chain retention

COLOUR 1



VOLCANO
GLOSS

BACK IN BLACK
GLOSS

POISON
GLOSS

Frame	Rocky Mountain 6061 Alloy. Threaded BB. Tapered Zerostack Headtube. Dropper Post Compatible.
Fork	Suntour XCM34 Boost 100mm
F / Brake	Shimano MT200
R / Brake	Shimano MT200
F / Rotor	Shimano RT10 160mm
R / Rotor	Shimano RT10 160mm
R / Shifter	SunRace DLM400 Trigger
R / Derailleur	Shimano Altus
Crankset	Rocky Mountain Microdrive 28T
Chainguide	Micro Chainguide
Bottom Bracket	FSA Sealed Cartridge Bearing
Pedals	Alloy Platform
Cassette	SunRace CSM680 11-40T
Chain	KMC Z8.3
F / Hub	Shimano MT400 Boost 15mm
R / Hub	Shimano TX505
Spokes	2.0 Stainless
F / Rim	Alex MD35
R / Rim	Alex MD35
F / Rim Tape	Tubeless Compatible - Tape / Valves / Sealant Not Incl.
R / Rim Tape	Tubeless Compatible - Tape / Valves / Sealant Not Incl.
F / Tire	WTB Ranger 26 x 2.8 Comp
R / Tire	WTB Ranger 26 x 2.8 Comp
Headset	FSA No. 57B
Stem	Rocky Mountain XC
Handlebar	Rocky Mountain XC 720mm
Grips / Tape	Rocky Mountain Lock On Light
Seatpost	Rocky Mountain Pivotal 30.9mm
Saddle	Rocky Mountain Pivotal Kids

B0060

MSRP

Growler Jr 24

MODEL HIGHLIGHTS

- Rocky Mountain trail performance for young riders
- Big tires for grip and control
- Enough travel to keep you out of trouble & tame bounce
- Simple 1x drivetrain

COLOUR 1



NEVERMIND
MATTE

BACK IN BLACK
MATTE

YELLOW SUBMARINE
MATTE

Frame	Rocky Mountain 6061 Alloy. Threaded BB. Tapered Zerostack Headtube. Dropper Post Compatible.
Fork	Suntour XCM30 80mm
F / Brake	Shimano MT200
R / Brake	Shimano MT200
F / Rotor	Shimano RT10 160mm
R / Rotor	Shimano RT10 160mm
R / Shifter	SunRace DLM400 Trigger
R / Derailleur	Shimano Altus
Crankset	Rocky Mountain Microdrive 28T
Chainguide	Micro Chainguide
Bottom Bracket	VP Sealed Cartridge Bearing
Pedals	Nylon Platform
Cassette	SunRace CSM680 11-40T
Chain	KMC Z8.3
F / Hub	Shimano MT400 Boost 15mm
R / Hub	Shimano TX505
Spokes	2.0 Stainless
F / Rim	Rocky Mountain JR30
R / Rim	Rocky Mountain JR30
F / Tire	VeeTire Crown GEM 24x2.6
R / Tire	VeeTire Crown GEM 24x2.6
Headset	FSA No. 57B-1
Stem	Rocky Mountain XC
Handlebar	Rocky Mountain XC 700mm
Grips / Tape	Rocky Mountain Lock On Light
Seatpost	Rocky Mountain Pivotal 30.9mm
Saddle	Rocky Mountain Pivotal Kids

VERTEX JR

DESIGNED FOR
Youth XC

FRONT TRAVEL
65 MM

WHEEL SIZE
20 & 24"

Disc-brake equipped, performance kids' bike—perfect for getting their first tracks on dirt.

Whether they're riding to school or ripping it up on dirt, lightweight and great performance are important for younger riders too. Our disc-brake equipped Vertex kids' bikes are ready to help instill a lifelong love of having fun on two wheels.

FRAME TECHNOLOGY



RMB 6061
ALLOY

NOTES

Rider:
Jett Westerlund

Photo:
Bryan Ralph

Location:
Washington, USA



VERTEX JR

GEOMETRY

- HTA** *Head Tube Angle (deg)*
- STA** *Seat Tube Angle (deg)*
- STL** *Seat Tube Length (mm)*
- TTH** *Top Tube Horizontal (mm)*
- HTL** *Head Tube Length (mm)*
- RC** *Rear Centre (mm)*
- BBD** *Bottom Bracket Drop (mm)*
- SH** *Standover Height (mm)*
- WB** *Wheelbase (mm)*
- R** *Reach (mm)*
- S** *Stack (mm)*

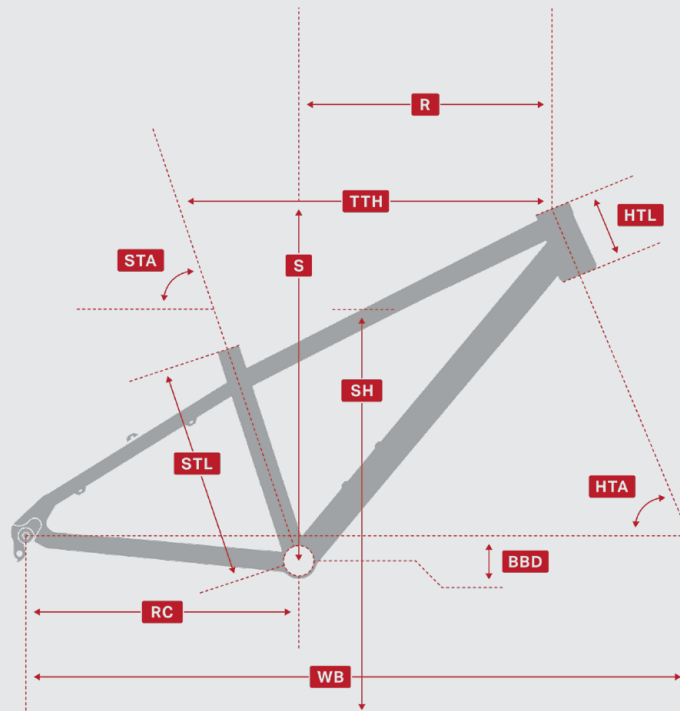

	Vertex 24	Vertex 20
	13"	10"
HTA	68°	68°
STA	72°	71°
STL	310	255
TTH	515	470
HTL	100	100
RC	382	347
BBD	40	15
SH	643	550
WB	955	872
R	355	323
S	492	428

VERTEX JR COLOURWAYS

Vertex Jr 24

COLOUR 1



TOUCH OF GREY
GLOSS

BACK IN BLACK
GLOSS

ACID RAIN
GLOSS

Vertex Jr 20

COLOUR 1



FLAMING LIPS
GLOSS

BACK IN BLACK
GLOSS

BILLY OCEAN
GLOSS

B0049

MSRP

Vertex Jr 24

MODEL HIGHLIGHTS

- Lightweight kids XC bike
- Killer paint job!
- Air sprung suspension fork
- Powerful hydraulic disc brakes, easy to set up for small hands
- Simple 1x drivetrain

IMPROVEMENTS OVER PREVIOUS MODEL

- Chain guide for reliable chain retention

COLOUR 1



TOUCH OF GREY
GLOSS

BACK IN BLACK
GLOSS

ACID RAIN
GLOSS

Frame	Rocky Mountain 6061 SL Alloy. Threaded BB. Zero Stack Headtube. 24" Kid's Geometry
Fork	Suntour XCR LO Air 65mm
F / Brake	Shimano MT201
R / Brake	Shimano MT201
F / Rotor	Shimano RT30 160mm
R / Rotor	Shimano RT30 160mm
R / Shifter	Sram X5
R / Derailleur	Sram X5
Crankset	Rocky Mountain Microdrive 2PC 28T
Chainguide	Micro Chainguide
Bottom Bracket	Rocky Mountain Sealed - Shimano Compatible
Pedals	Nylon Platform
Cassette	SunRace CSM980 11-40T
Chain	KMC X9
F / Hub	Shimano TX505
R / Hub	Shimano TX505
Spokes	2.0 Stainless
F / Rim	WTB SX17
R / Rim	WTB SX17
F / Tire	VeeTire Crown GEM 24x2.25
R / Tire	VeeTire Crown GEM 24x2.25
Headset	FSA No. 10P
Stem	Rocky Mountain XC
Handlebar	Rocky Mountain XC 640mm
Grips / Tape	Rocky Mountain Slide On Kids
Seatpost	Rocky Mountain Pivotal 27.2mm
Saddle	Rocky Mountain Pivotal Kids

B0050

MSRP

Vertex Jr 20

MODEL HIGHLIGHTS

- Lightweight kids XC bike
- Killer paint job!
- Air sprung suspension fork
- Powerful hydraulic disc brakes, easy to set up for small hands
- Simple 1x drivetrain

IMPROVEMENTS OVER PREVIOUS MODEL

- Chain guide for reliable chain retention

COLOUR 1



FLAMING LIPS
GLOSS

BACK IN BLACK
GLOSS

BILLY OCEAN
GLOSS

Frame	Rocky Mountain 6061 SL Alloy. Threaded BB. Zero Stack Headtube. 20" Kid's Geometry
Fork	Suntour XCM JR Air 80mm
F / Brake	Shimano MT200
R / Brake	Shimano MT200
F / Rotor	Shimano RT10 160mm
R / Rotor	Shimano RT10 160mm
R / Shifter	Sram X5
R / Derailleur	Sram X4
Crankset	Rocky Mountain Microdrive 28T
Chainguide	Micro Chainguide
Bottom Bracket	SR Suntour Sealed Cartridge Bearing
Pedals	Composite Kids
Cassette	SunRace CSM98 11-36T
Chain	KMC X9
F / Hub	Shimano TX500
R / Hub	Shimano TX505
Spokes	2.0 Stainless
F / Rim	WTB SX17
R / Rim	WTB SX17
F / Tire	VeeTire Crown GEM 20x2.25
R / Tire	VeeTire Crown GEM 20x2.25
Headset	FSA No. 10P
Stem	Rocky Mountain XC
Handlebar	Rocky Mountain XC 600mm
Grips / Tape	Rocky Mountain Slide On Kids
Seatpost	Rocky Mountain Pivotal 27.2mm
Saddle	Rocky Mountain Pivotal Kids

SOUL JR

DESIGNED FOR
Youth Trail

FRONT TRAVEL
63 MM

WHEEL SIZE
20 & 24"

From ripping around the cul-de-sac to exploring the woods, you'll be in total control riding the Soul Jr.

The Soul Jr is ready to tear up the neighbourhood. Whether you're building your first jumps out of plywood, riding to and from the park, or headed out with your friends, the Soul has you covered. Available in two different wheel sizes, both models are spec'd with a 1x drivetrain and mechanical disc brakes to ensure comfort and control.

FRAME TECHNOLOGY



RMB 6061
ALLOY

NOTES

Riders:
Wade & Elliott Simmons

Photo:
Margus Riga

Location:
North Vancouver, BC



SOUL JR

GEOMETRY

- HTA** Head Tube Angle (deg)
- STA** Seat Tube Angle (deg)
- STL** Seat Tube Length (mm)
- TTH** Top Tube Horizontal (mm)
- HTL** Head Tube Length (mm)
- RC** Rear Centre (mm)
- BBD** Bottom Bracket Drop (mm)
- SH** Standover Height (mm)
- WB** Wheelbase (mm)
- R** Reach (mm)
- S** Stack (mm)

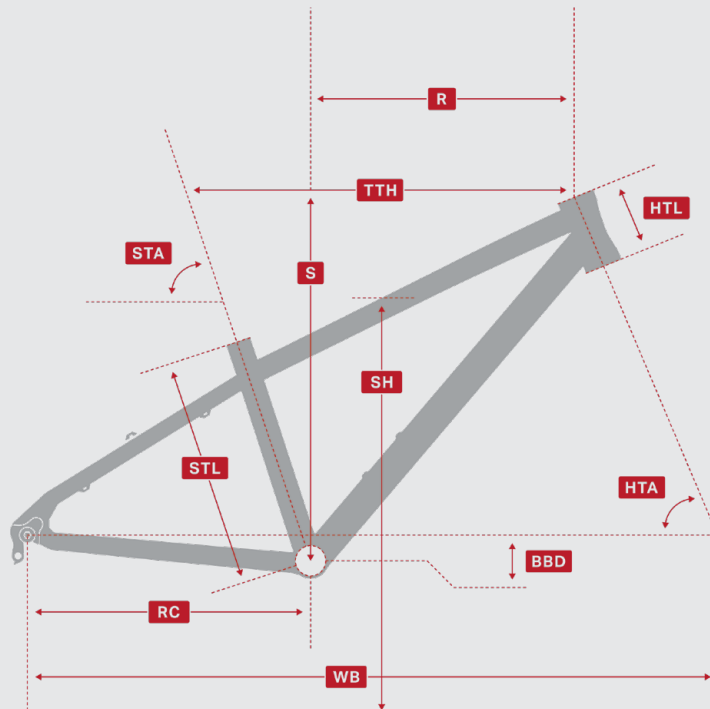

Soul Jr 24

Soul Jr 20

	12"	10"
HTA	68°	68°
STA	72°	71°
STL	310	255
TTH	515	470
HTL	100	100
RC	382	347
BBD	40	15
SH	645	555
WB	955	872
R	355	323
S	492	428

SOUL JR COLOURWAYS

Soul 24

COLOUR 1



Soul 20

COLOUR 1



B0051

MSRP

Soul Jr 24

MODEL HIGHLIGHTS

- All around kids bike
- Extra low standover clearance for young rippers
- Coil sprung suspension fork
- Mechanical disc brakes, 4 finger levers for small hands
- Simple 1x drivetrain

IMPROVEMENTS OVER PREVIOUS MODEL

- Chain guide for reliable chain retention

COLOUR 1



FLAMING LIPS
GLOSS

BACK IN BLACK
GLOSS

BILLY OCEAN
GLOSS

Frame	Rocky Mountain 6061 SL Alloy. Threaded BB. Zero Stack Headtube. 24" Kid's Geometry
Fork	Suntour XCR LO Coil 63mm
F / Brake	Shimano TX805
R / Brake	Shimano TX805
F / Brake Lever	Tektro Alloy 4 Finger
R / Brake Lever	Tektro Alloy 4 Finger
F / Rotor	Shimano RT10 160mm
R / Rotor	Shimano RT10 160mm
R / Shifter	SunRace DLM400 Trigger
R / Derailleur	Shimano Altus
Crankset	Rocky Mountain Microdrive 28T
Chainguide	Micro Chainguide
Bottom Bracket	Sealed Cartridge Bearing
Pedals	Composite Kids
Cassette	SunRace CSM680 11-40T
Chain	KMC Z8.3
F / Hub	Shimano TX505
R / Hub	Shimano TX505
Spokes	2.0 Stainless
F / Rim	WTB SX17
R / Rim	WTB SX17
F / Tire	VeeTire Crown GEM 24x2.25
R / Tire	VeeTire Crown GEM 24x2.25
Headset	FSA No. 10P
Stem	Rocky Mountain XC
Handlebar	Rocky Mountain XC 640mm
Grips / Tape	Rocky Mountain Slide On Kids
Seatpost	Rocky Mountain Pivotal 27.2mm
Saddle	Rocky Mountain Pivotal Kids

B0052

MSRP

Soul Jr 20

MODEL HIGHLIGHTS

- All around kids bike
- Extra low standover clearance for young rippers
- Coil sprung suspension fork
- Mechanical disc brakes, 4 finger levers for small hands
- Simple 1x drivetrain

IMPROVEMENTS OVER PREVIOUS MODEL

- Chain guide for reliable chain retention

COLOUR 1



NEVERMIND
MATTE

BACK IN BLACK
MATTE

POISON
MATTE

Frame	Rocky Mountain 6061 SL Alloy. Threaded BB. Zero Stack Headtube. 20" Kid's Geometry
Fork	Suntour XCT JR 63mm
F / Brake	Shimano TX805
R / Brake	Shimano TX805
F / Brake Lever	Tektro Alloy 4 Finger
R / Brake Lever	Tektro Alloy 4 Finger
F / Rotor	Shimano RT10 160mm
R / Rotor	Shimano RT10 160mm
R / Shifter	SunRace DLM400 Trigger
R / Derailleur	Shimano Altus
Crankset	Rocky Mountain Jr Alloy 28T
Bottom Bracket	Sealed Cartridge Bearing
Pedals	Composite Kids
Cassette	SunRace CSM55 11-34T
Chain	KMC Z8.3
F / Hub	Shimano TX505
R / Hub	Shimano TX505
Spokes	2.0 Stainless
F / Rim	WTB SX17
R / Rim	WTB SX17
F / Tire	VeeTire Crown GEM 20x2.25
R / Tire	VeeTire Crown GEM 20x2.25
Headset	FSA No. 10P
Stem	Rocky Mountain XC
Handlebar	Rocky Mountain XC 600mm
Grips / Tape	Rocky Mountain Slide On Kids
Seatpost	Rocky Mountain Pivotal 27.2mm
Saddle	Rocky Mountain Pivotal Kids

The Powerplay family, powered by Dyname, continues to grow. The Instinct Powerplay will be introduced in Carbon, and our aggressive BC Edition now has an eMTB version. Powerplay leads the way with diversity, quality, and – most of all – a great ride.

Powerplay

POWERED BY

DYNAME™

Riders:
Wade Simmons
& Andreas Hestler

Photo:
Margus Riga

Location:
Vancouver Island, BC

What makes Powerplay different

A drive that responds immediately when you start. Intuitive everything. A sublime profile. More power. Tons of torque.

While developing the first-ever Rocky Mountain eMTB, we refused to be held hostage by existing drive designs. We built the drive to fit the bike, not the other way around. For ten years, our engineers dreamed, created, tested and meticulously improved upon Dynamer until they got it right. The Dynamer drive is compact, powerful, and smooth. It facilitates pure, unbridled design freedom, as evidenced by the seamless integration of the RIDE-9 adjustment system.



But where's the battery?

Fully integrated into downtube for lighter weight, increased durability and sweet aesthetics.



Force to the frame

Your pedalling force goes into the front triangle, not the drive. You can use real two-piece Race Face cranks, not eMTB cranks, as a result.



iWoc remote

Compact. Bluetooth-enabled. All the info you need; none you don't.



Customizable app

Escape the tyranny of factory settings. Pick your own levels of power-assist.



Get up and go

Patented torque sensing technology means instant gratification, unlike anything else on the market.



INSTINCT POWER PLAY

DESIGNED FOR
Trail

FRONT TRAVEL
140 MM

REAR TRAVEL
140 MM

WHEEL SIZE
29" (27.5+ ready)

The Instinct Powerplay will take you to the places you never thought possible. When it comes time to head out the door for that all-day ride into the alpine, you'll be riding further and faster than ever before on what is our most versatile eMTB yet.

Taking our Powerplay line up the next level, the Instinct Powerplay integrates our powerful DynamE 3.0 drive system on a 29" wheeled platform for fast rolling rides and long distances. Featuring the iWoc TRIO remote, our RIDE-9 adjustment system, tweaked suspension kinematics, and great small-bump sensitivity, the Instinct Powerplay is perfect for the big epic rides!







NOTES

Rider:
Andreas Hestler

Photo:
Margus Riga

Location:
Howe Sound, BC

FRAME TECHNOLOGY

-  **DynamE 3.0**
DRIVE SYSTEM
-  **Smoothwall Carbon**
FRAME MATERIAL
-  **FORM Alloy**
FRAME MATERIAL
-  **RIDE-9**
ADJUSTMENT SYSTEM
-  **Smoothlink**
SUSPENSION
-  **Size Specific**
TUNE



INSTINCT POWERPLAY CARBON & ALLOY

GEOMETRY

Geometry shown for Slack, Neutral, and Steep RIDE-9™ positions.

- HTA** Head Tube Angle (deg)
- STA** Seat Tube Angle (deg)
- STL** Seat Tube Length (mm)
- TTH** Top Tube Horizontal (mm)
- HTL** Head Tube Length (mm)
- RC** Rear Centre (mm)
- BBD** Bottom Bracket Drop (mm)
- SH** Standover Height (mm)
- WB** Wheelbase (mm)
- R** Reach (mm)
- S** Stack (mm)

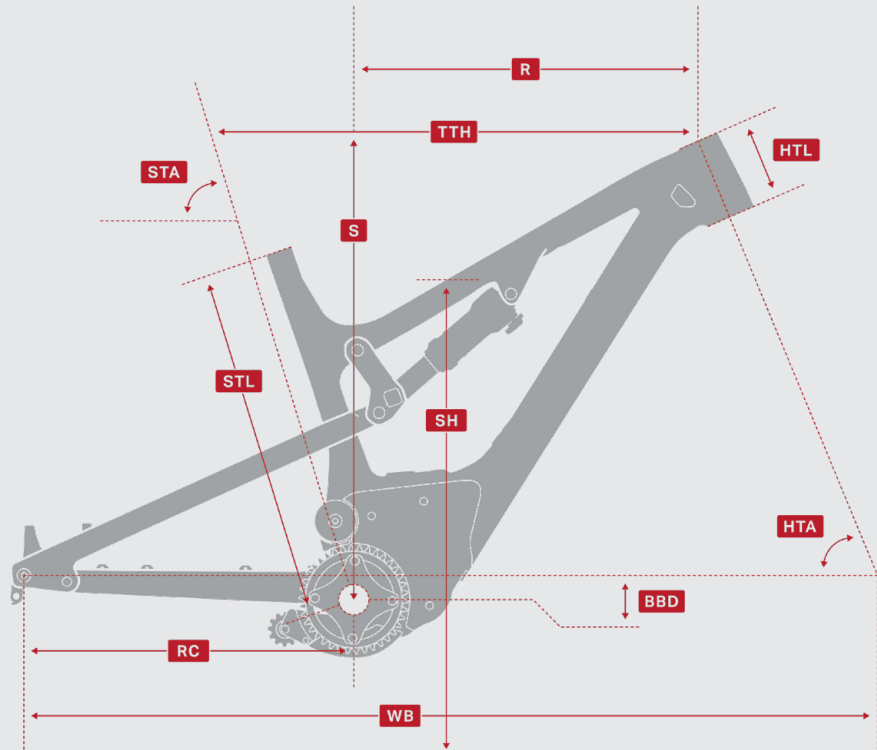

	SM			MD			LG			XL		
	Slack	Neutral	Steep	Slack	Neutral	Steep	Slack	Neutral	Steep	Slack	Neutral	Steep
HTA	66°	66.5°	67.1°	66°	66.5°	67°	66°	66.5°	67°	66°	66.5°	67°
STA	74.7°	75.2°	75.7°	74.7°	75.3°	75.8°	74.6°	75.1°	75.6°	74.6°	75.1°	75.6°
STL	394	394	394	432	432	432	470	470	470	508	508	508
TTH	575	573	572	599	597	596	625	624	622	656	654	653
HTL	100	100	100	100	100	100	110	110	110	120	120	120
RC	443	442	441	443	442	441	443	442	441	443	442	441
BBD	36.4	30	23.1	36.6	30	23	36.6	30	22.9	36.8	30	22.8
SH	816	818	821	810	812	815	808	811	814	806	809	812
WB	1161	1161	1160	1187	1186	1185	1213	1213	1212	1245	1244	1243
R	407	412	418	432	437	443	455	460	441	482	487	493
S	611	608	604	611	608	603	621	617	612	630	626	622

INSTINCT POWERPLAY COLOURWAYS

Carbon 90 / 70 / 50

COLOUR 1

Instinct Powerplay Carbon 90 shown



SUNDAY BLOODY SUNDAY
GLOSS

FLAMING LIPS
GLOSS

BACK IN BLACK
GLOSS

Carbon 90 / 70 / 50

COLOUR 2

Instinct Powerplay Carbon 90 shown



FOLSOM PRISON BLUE
GLOSS

NEVERMIND
MATTE

BACK IN BLACK
MATTE

B0067

MSRP

Instinct Powerplay Carbon 90

MODEL HIGHLIGHTS

- Stiff & lightweight Carbon front triangle
- Sleek, fully integrated design
- Intuitive & smooth DynamE 3.0 electric assist
- Super high torque drive output
- High capacity 672 Wh battery
- Fast charging: 500 Wh in 2 hrs, full in 3:25 from empty!

COLOUR 1



SUNDAY BLOODY SUNDAY
GLOSS

FLAMING LIPS
GLOSS

BACK IN BLACK
GLOSS

COLOUR 2



FOLSOM PRISON BLUE
GLOSS

NEVERMIND
MATTE

BACK IN BLACK
MATTE

Front Triangle

Smoothwall Carbon. Full Sealed Cartridge Bearings. Press Fit BB. Internal Cable Routing. 2-Bolt ISCG05 Tabs. RIDE-9 Adjustable Geometry + Suspension Rate. 140mm Travel.

Chainstay

FORM Alloy

Seatstay

FORM Alloy

Drive System

DynamE 3.0 Drive 250w / 48v. iWoc TRIO Remote

Battery

Li-Ion 672 Watt/Hr

Fork

RockShox Pike Ultimate RCT3 140mm E-MTB Approved 42mm Offset

Rear Shock

RockShox Deluxe Ultimate RCT

F / Brake

Sram Code RSC

R / Brake

Sram Code RSC

F / Rotor

Sram Centerline 200mm

R / Rotor

Sram Centerline 200mm

R / Shifter

Sram X01E Eagle

R / Derailleur

Sram X01 Eagle

Crankset

Race Face Turbine Cinch 34T

Bottom Bracket

Race Face BB92 30mm

Cassette

Sram PG-1230 11-50T

Chain

Sram NX Eagle. E-MTB Approved.

F / Hub

Rocky Mountain Sealed Boost 15mm Torque Cap

R / Hub

DT Swiss Hybrid 350 Boost 148mm

Spokes

DT Swiss Alpine 2.3/2.0

F / Rim

Race Face ARC 35

R / Rim

Race Face ARC 35

F / Rim Tape

Tubeless Ready - Tape / Valves Incl.

R / Rim Tape

Tubeless Ready - Tape / Valves Incl.

F / Tire

Maxxis Minion DHF EXO+ Maxx Terra Tubeless Ready 29 x 2.6

R / Tire

Maxxis Rekon Maxx Terra EXO+ Silk Shield Tubeless Ready 29 x 2.6

Headset

FSA Orbit NO.57E

Stem

Rocky Mountain 35 CNC

Handlebar

Race Face Next R 780mm

Grips / Tape

Rocky Mountain Lock On XC

Seatpost

Race Face Turbine R (by Fox) Dropper 30.9mm

Saddle

WTB Volt Race 142

Accessories

Offside Dual Waterbottle Adapter

B0068

MSRP

Instinct Powerplay Carbon 70 (SRAM)

MODEL HIGHLIGHTS

- Stiff & lightweight Carbon front triangle
- Sleek, fully integrated design
- Intuitive & smooth DynamE 3.0 electric assist
- Super high torque drive output
- High capacity 672 Wh battery
- Fast charging: 500 Wh in 2 hrs, full in 3:25 from empty!

COLOUR 1



SUNDAY BLOODY SUNDAY
GLOSS

FLAMING LIPS
GLOSS

BACK IN BLACK
GLOSS

COLOUR 2



FOLSOM PRISON BLUE
GLOSS

NEVERMIND
MATTE

BACK IN BLACK
MATTE

Front Triangle	Smoothwall Carbon. Full Sealed Cartridge Bearings. Press Fit BB. Internal Cable Routing. 2-Bolt ISCG05 Tabs. RIDE-9 Adjustable Geometry + Suspension Rate. 140mm Travel.
Chainstay	FORM Alloy
Seatstay	FORM Alloy
Drive System	DynamE 3.0 Drive 250w / 48v. iWoc TRIO Remote
Battery	Li-Ion 672 Watt/Hr
Fork	Fox 36 E-MTB Float EVOL FIT4 Performance Elite Series 140mm 44mm Offset
Rear Shock	Fox Float DPS EVOL Performance
F / Brake	Shimano XT Trail 4 Piston
R / Brake	Shimano XT Trail 4 Piston
F / Rotor	Shimano RT66 203mm
R / Rotor	Shimano RT66 203mm
R / Shifter	Sram GX-1E Eagle
R / Derailleur	Sram GX Eagle
Crankset	Race Face Turbine Cinch 34T
Bottom Bracket	Race Face BB92 30mm
Cassette	Sram PG-1230 11-50T
Chain	Sram NX Eagle. E-MTB Approved.
F / Hub	Rocky Mountain Sealed Boost 15mm
R / Hub	DT Swiss Hybrid 370 Boost 148mm
Spokes	DT Swiss Alpine 2.3/2.0
F / Rim	Race Face AR 35
R / Rim	Race Face AR 35
F / Rim Tape	Tubeless Ready - Tape / Valves Incl.
R / Rim Tape	Tubeless Ready - Tape / Valves Incl.
F / Tire	Maxxis Minion DHF EXO+ Maxx Terra Tubeless Ready 29 x 2.6
R / Tire	Maxxis Rekon Maxx Terra EXO+ Silk Shield Tubeless Ready 29 x 2.6
Headset	FSA Orbit NO.57E
Stem	Rocky Mountain 35 AM
Handlebar	Rocky Mountain AM 780mm
Grips / Tape	Rocky Mountain Lock On XC
Seatpost	Race Face Turbine R (by Fox) Dropper 30.9mm
Saddle	WTB Volt Race 142
Accessories	Offside Dual Waterbottle Adapter

B0085

MSRP

Instinct Powerplay Carbon 70 (SHIMANO)

MODEL HIGHLIGHTS

- Stiff & lightweight Carbon front triangle
- Sleek, fully integrated design
- Intuitive & smooth DynamE 3.0 electric assist
- Super high torque drive output
- High capacity 672 Wh battery
- Fast charging: 500 Wh in 2 hrs, full in 3:25 from empty!

COLOUR 1



SUNDAY BLOODY SUNDAY
GLOSS

FLAMING LIPS
GLOSS

BACK IN BLACK
GLOSS

COLOUR 2



FOLSOM PRISON BLUE
GLOSS

NEVERMIND
MATTE

BACK IN BLACK
MATTE

Front Triangle	Smoothwall Carbon. Full Sealed Cartridge Bearings. Press Fit BB. Internal Cable Routing. 2-Bolt ISCG05 Tabs. RIDE-9 Adjustable Geometry + Suspension Rate. 140mm Travel.
Chainstay	FORM Alloy
Seatstay	FORM Alloy
Drive System	DynamE 3.0 Drive 250w / 48v. iWoc TRIO Remote
Battery	Li-Ion 672 Watt/Hr
Fork	Fox 36 E-MTB Float EVOL FIT4 Performance Elite Series 140mm 44mm Offset
Rear Shock	Fox Float DPS EVOL Performance
F / Brake	Shimano XT Trail 4 Piston
R / Brake	Shimano XT Trail 4 Piston
F / Rotor	Shimano RT66 203mm
R / Rotor	Shimano RT66 203mm
R / Shifter	Shimano XT
R / Derailleur	Shimano XT
Crankset	Race Face Aeffect Cinch 34T
Bottom Bracket	Shimano SM-BB71
Cassette	Shimano XT 10-51T
Chain	Shimano HG8100
F / Hub	Rocky Mountain Sealed Boost 15mm
R / Hub	DT Swiss Hybrid 370 Boost 148mm
Spokes	DT Swiss Alpine 2.3/2.0
F / Rim	Race Face AR 35
R / Rim	Race Face AR 35
F / Rim Tape	Tubeless Ready - Tape / Valves Incl.
R / Rim Tape	Tubeless Ready - Tape / Valves Incl.
F / Tire	Maxxis Minion DHF EXO+ Maxx Terra Tubeless Ready 29 x 2.6
R / Tire	Maxxis Rekon Maxx Terra EXO+ Silk Shield Tubeless Ready 29 x 2.6
Headset	FSA Orbit NO.57E
Stem	Rocky Mountain 35 AM
Handlebar	Rocky Mountain AM 780mm
Grips / Tape	Rocky Mountain Lock On XC
Seatpost	Race Face Turbine R (by Fox) Dropper 30.9mm
Saddle	WTB Volt Race 142
Accessories	Offside Dual Waterbottle Adapter

B0069

MSRP

Instinct Powerplay Carbon 50 (SRAM)

MODEL HIGHLIGHTS

- Stiff & lightweight Carbon front triangle
- Sleek, fully integrated design
- Intuitive & smooth DynamE 3.0 electric assist
- Super high torque drive output
- High capacity 672 Wh battery
- Fast charging: 500 Wh in 2 hrs, full in 3:25 from empty!

COLOUR 1



SUNDAY BLOODY SUNDAY
GLOSS

FLAMING LIPS
GLOSS

BACK IN BLACK
GLOSS

COLOUR 2



FOLSOM PRISON BLUE
GLOSS

NEVERMIND
MATTE

BACK IN BLACK
MATTE

Front Triangle	Smoothwall Carbon. Full Sealed Cartridge Bearings. Press Fit BB. Internal Cable Routing. 2-Bolt ISCG05 Tabs. RIDE-9 Adjustable Geometry + Suspension Rate. 140mm Travel.
Chainstay	FORM Alloy
Seatstay	FORM Alloy
Drive System	DynamE 3.0 Drive 250w / 48v. iWoc TRIO Remote
Battery	Li-Ion 672 Watt/Hr
Fork	RockShox Pike Select RC 140mm E-MTB Approved 42mm Offset
Rear Shock	RockShox Deluxe Select+ RT
F / Brake	Shimano MT520 4 Piston
R / Brake	Shimano MT520 4 Piston
F / Rotor	Shimano RT66 203mm
R / Rotor	Shimano RT66 203mm
R / Shifter	Sram NX-1E Eagle
R / Derailleur	Sram GX Eagle
Crankset	Race Face Ride Cinch 34T
Bottom Bracket	Shimano SM-BBMT500
Cassette	Sram PG-1230 11-50T
Chain	Sram NX Eagle. E-MTB Approved.
F / Hub	Rocky Mountain Sealed Boost 15mm Torque Cap
R / Hub	DT Swiss Hybrid 370 Boost 148mm
Spokes	DT Swiss Alpine 2.3/2.0
F / Rim	WTB ST i35 TCS 2.0 Tubeless
R / Rim	WTB ST i35 TCS 2.0 Tubeless
F / Rim Tape	Tubeless Ready - Tape / Valves Incl.
R / Rim Tape	Tubeless Ready - Tape / Valves Incl.
F / Tire	Maxxis Minion DHF EXO Tubeless Ready 29 x 2.6
R / Tire	Maxxis Rekon EXO+ Silk Shield Tubeless Ready 29 x 2.6
Headset	FSA Orbit NO.57E
Stem	Rocky Mountain 35 AM
Handlebar	Rocky Mountain AM 780mm
Grips / Tape	Rocky Mountain Lock On Light
Seatpost	Race Face Aeffect R Dropper 30.9mm
Saddle	WTB Volt Race 142
Accessories	Offside Dual Waterbottle Adapter

B0086

MSRP

Instinct Powerplay Carbon 50 (SHIMANO)

MODEL HIGHLIGHTS

- Stiff & lightweight Carbon front triangle
- Sleek, fully integrated design
- Intuitive & smooth DynamE 3.0 electric assist
- Super high torque drive output
- High capacity 672 Wh battery
- Fast charging: 500 Wh in 2 hrs, full in 3:25 from empty!

COLOUR 1



SUNDAY BLOODY SUNDAY
GLOSS

FLAMING LIPS
GLOSS

BACK IN BLACK
GLOSS

COLOUR 2



FOLSOM PRISON BLUE
GLOSS

NEVERMIND
MATTE

BACK IN BLACK
MATTE

Front Triangle	Smoothwall Carbon. Full Sealed Cartridge Bearings. Press Fit BB. Internal Cable Routing. 2-Bolt ISCG05 Tabs. RIDE-9 Adjustable Geometry + Suspension Rate. 140mm Travel.
Chainstay	FORM Alloy
Seatstay	FORM Alloy
Drive System	DynamE 3.0 Drive 250w / 48v. iWoc TRIO Remote
Battery	Li-Ion 672 Watt/Hr
Fork	RockShox Pike Select RC 140mm E-MTB Approved 42mm Offset
Rear Shock	RockShox Deluxe Select+ RT
F / Brake	Shimano MT520 4 Piston
R / Brake	Shimano MT520 4 Piston
F / Rotor	Shimano RT66 203mm
R / Rotor	Shimano RT66 203mm
R / Shifter	Shimano SLX
R / Derailleur	Shimano SLX
Crankset	Race Face Ride Cinch 34T
Bottom Bracket	Shimano SM-BBMT500
Cassette	Shimano SLX 10-51T
Chain	Shimano HG7100
F / Hub	Rocky Mountain Sealed Boost 15mm Torque Cap
R / Hub	DT Swiss Hybrid 370 Boost 148mm
Spokes	DT Swiss Alpine 2.3/2.0
F / Rim	WTB ST i35 TCS 2.0 Tubeless
R / Rim	WTB ST i35 TCS 2.0 Tubeless
F / Rim Tape	Tubeless Ready - Tape / Valves Incl.
R / Rim Tape	Tubeless Ready - Tape / Valves Incl.
F / Tire	Maxxis Minion DHF EXO Tubeless Ready 29 x 2.6
R / Tire	Maxxis Rekon EXO+ Silk Shield Tubeless Ready 29 x 2.6
Headset	FSA Orbit NO.57E
Stem	Rocky Mountain 35 AM
Handlebar	Rocky Mountain AM 780mm
Grips / Tape	Rocky Mountain Lock On Light
Seatpost	Race Face Aeffect R Dropper 30.9mm
Saddle	WTB Volt Race 142
Accessories	Offside Dual Waterbottle Adapter

INSTINCT POWERPLAY COLOURWAYS

Alloy 70 / 50 / 30

COLOUR 1

Instinct Powerplay Alloy 70 (Sram) shown



THE MAN IN BLACK
MATTE

THE MAN IN BLACK
GLOSS

FLAMING LIPS
MATTE/GLOSS

Alloy 70 / 50

COLOUR 2

Instinct Powerplay Alloy 70 (Sram) shown



FOLSOM PRISON BLUE
GLOSS

THE MAN IN BLACK
GLOSS

NEVERMIND
GLOSS

B0070

MSRP

Instinct Powerplay Alloy 70 (SRAM)

MODEL HIGHLIGHTS

- The Instinct is Rocky Mountain's most versatile platform
- Sleek, fully integrated design
- Intuitive & smooth Dynamac 3.0 electric assist
- Super high torque drive output
- High capacity 672 Wh battery
- Fast charging: 500 Wh in 2 hrs, full in 3:25 from empty!

IMPROVEMENTS OVER PREVIOUS MODEL

- Improved production tolerances and methods for increased drive reliability
- All new Powerplay chain slider for noise reduction
- Stiffer Fox 36 fork
- Shimano 4 piston brakes
- More robust tire construction

COLOUR 1



THE MAN IN BLACK
MATTE

THE MAN IN BLACK
GLOSS

FLAMING LIPS
MATTE/GLOSS

COLOUR 2



FOLSOM PRISON BLUE
GLOSS

THE MAN IN BLACK
GLOSS

NEVERMIND
GLOSS

Front Triangle	FORM Alloy. Full Sealed Cartridge Bearings. Press Fit BB. Internal Cable Routing. 2-Bolt ISCG05 Tabs. RIDE-9 Adjustable Geometry + Suspension Rate. 140mm Travel.
Chainstay	FORM Alloy
Seatstay	FORM Alloy
Drive System	Dynamac 3.0 Drive 250w / 48v. iWoc TRIO Remote
Battery	Li-Ion 672 Watt/Hr
Fork	Fox 36 E-MTB Float EVOL GRIP Performance Series 140mm 44mm Offset
Rear Shock	Fox Float DPS EVOL Performance
F / Brake	Shimano XT Trail 4 Piston
R / Brake	Shimano XT Trail 4 Piston
F / Rotor	Shimano RT66 203mm
R / Rotor	Shimano RT66 203mm
R / Shifter	Sram NX-1E Eagle
R / Derailleur	Sram GX Eagle
Crankset	Race Face Aeffect Cinch 34T
Bottom Bracket	Shimano SM-BBMT500
Cassette	Sram PG-1230 11-50T
Chain	Sram NX Eagle. E-MTB Approved.
F / Hub	Rocky Mountain Sealed Boost 15mm
R / Hub	DT Swiss Hybrid 370 Boost 148mm
Spokes	DT Swiss Alpine 2.3/2.0
F / Rim	WTB ST i35 TCS 2.0 Tubeless
R / Rim	WTB ST i35 TCS 2.0 Tubeless
F / Rim Tape	Tubeless Ready - Tape / Valves Incl.
R / Rim Tape	Tubeless Ready - Tape / Valves Incl.
F / Tire	Maxxis Minion DHF EXO Tubeless Ready 29 x 2.6
R / Tire	Maxxis Rekon EXO+ Silk Shield Tubeless Ready 29 x 2.6
Headset	FSA Orbit NO.57E
Stem	Rocky Mountain 35 AM
Handlebar	Rocky Mountain AM 780mm
Grips / Tape	Rocky Mountain Lock On Light
Seatpost	Race Face Turbine R (by Fox) Dropper 30.9mm
Saddle	WTB Volt Race 142
Accessories	Offside Dual Waterbottle Adapter

B0087

MSRP

Instinct Powerplay Alloy 70 (SHIMANO)

MODEL HIGHLIGHTS

- The Instinct is Rocky Mountain's most versatile platform
- Sleek, fully integrated design
- Intuitive & smooth DynamE 3.0 electric assist
- Super high torque drive output
- High capacity 672 Wh battery
- Fast charging: 500 Wh in 2 hrs, full in 3:25 from empty!

IMPROVEMENTS OVER PREVIOUS MODEL

- Improved production tolerances and methods for increased drive reliability
- All new Powerplay chain slider for noise reduction
- Stiffer RockShox Pike fork
- Shimano 4 piston brakes
- More robust tires

COLOUR 1



THE MAN IN BLACK
MATTE

THE MAN IN BLACK
GLOSS

FLAMING LIPS
MATTE/GLOSS

COLOUR 2



FOLSOM PRISON BLUE
GLOSS

THE MAN IN BLACK
GLOSS

NEVERMIND
GLOSS

Front Triangle	FORM Alloy. Full Sealed Cartridge Bearings. Press Fit BB. Internal Cable Routing. 2-Bolt ISCG05 Tabs. RIDE-9 Adjustable Geometry + Suspension Rate. 140mm Travel.
Chainstay	FORM Alloy
Seatstay	FORM Alloy
Drive System	DynamE 3.0 Drive 250w / 48v. iWoc TRIO Remote
Battery	Li-Ion 672 Watt/Hr
Fork	RockShox Pike Select RC 140mm E-MTB Approved 42mm Offset
Rear Shock	RockShox Deluxe Select+ RT
F / Brake	Shimano XT
R / Brake	Shimano XT
F / Rotor	Shimano RT66 203mm
R / Rotor	Shimano RT66 203mm
R / Shifter	Shimano XT
R / Derailleur	Shimano XT
Crankset	Race Face Aeffect Cinch 34T
Bottom Bracket	Shimano SM-BBMT500
Cassette	Shimano XT 10-51T
Chain	Shimano HG8100
F / Hub	Rocky Mountain Sealed Boost 15mm
R / Hub	DT Swiss Hybrid 370 Boost 148mm
Spokes	DT Swiss Alpine 2.3/2.0
F / Rim	WTB ST i35 TCS 2.0 Tubeless
R / Rim	WTB ST i35 TCS 2.0 Tubeless
F / Rim Tape	Tubeless Ready - Tape / Valves Incl.
R / Rim Tape	Tubeless Ready - Tape / Valves Incl.
F / Tire	Maxxis Minion DHF EXO Tubeless Ready 29 x 2.6
R / Tire	Maxxis Rekon EXO+ Silk Shield Tubeless Ready 29 x 2.6
Headset	FSA Orbit NO.57E
Stem	Rocky Mountain 35 AM
Handlebar	Rocky Mountain AM 780mm
Grips / Tape	Rocky Mountain Lock On Light
Seatpost	Rocky Mountain Toonie Drop 30.9mm
Saddle	WTB Volt Race 142
Accessories	Offside Dual Waterbottle Adapter

B0071

MSRP

Instinct Powerplay Alloy 50 (SRAM)

MODEL HIGHLIGHTS

- The Instinct is Rocky Mountain's most versatile platform
- Sleek, fully integrated design
- Intuitive & smooth Dynamac 3.0 electric assist
- Super high torque drive output
- High capacity 672 Wh battery
- Fast charging: 500 Wh in 2 hrs, full in 3:25 from empty!

IMPROVEMENTS OVER PREVIOUS MODEL

- Improved production tolerances and methods for increased drive reliability
- 672 Wh battery
- All new Powerplay chain slider for noise reduction
- Stiffer RockShox Pike fork
- Shimano 4 piston brakes
- More robust tire construction

COLOUR 1



THE MAN IN BLACK
MATTE

THE MAN IN BLACK
GLOSS

FLAMING LIPS
MATTE/GLOSS

COLOUR 2



FOLSOM PRISON BLUE
GLOSS

THE MAN IN BLACK
GLOSS

NEVERMIND
GLOSS

Front Triangle	FORM Alloy. Full Sealed Cartridge Bearings. Press Fit BB. Internal Cable Routing. 2-Bolt ISCG05 Tabs. RIDE-9 Adjustable Geometry + Suspension Rate. 140mm Travel.
Chainstay	FORM Alloy
Seatstay	FORM Alloy
Drive System	Dynamac 3.0 Drive 250w / 48v. iWoc TRIO Remote
Battery	Li-Ion 672 Watt/Hr
Fork	RockShox Pike Select RC 140mm E-MTB Approved 42mm Offset
Rear Shock	RockShox Deluxe Select+ RT
F / Brake	Shimano MT520 4 Piston
R / Brake	Shimano MT520 4 Piston
F / Rotor	Shimano RT64 203mm
R / Rotor	Shimano RT64 203mm
R / Shifter	Sram NX-1E Eagle
R / Derailleur	Sram GX Eagle
Crankset	Race Face Ride Cinch 34T
Bottom Bracket	Shimano SM-BBMT500
Cassette	Sram PG-1210 11-50T
Chain	Sram SX Eagle. E-MTB Approved.
F / Hub	Shimano MT400 Boost 15mm
R / Hub	Shimano MT400 Boost 148mm
Spokes	DT Swiss Champion 2.0
F / Rim	WTB ST i35 TCS 2.0 Tubeless
R / Rim	WTB ST i35 TCS 2.0 Tubeless
F / Rim Tape	Tubeless Ready - Tape / Valves Incl.
R / Rim Tape	Tubeless Ready - Tape / Valves Incl.
F / Tire	Maxxis Minion DHF EXO Tubeless Ready 29 x 2.6
R / Tire	Maxxis Rekon EXO+ Silk Shield Tubeless Ready 29 x 2.6
Headset	FSA Orbit NO.57E
Stem	Rocky Mountain AM
Handlebar	Rocky Mountain AM 760mm
Grips / Tape	Rocky Mountain Lock On Light
Seatpost	Race Face Aeffect R Dropper 30.9mm
Saddle	WTB Volt Race 142
Accessories	Offside Dual Waterbottle Adapter

B0088

MSRP

Instinct Powerplay Alloy 50 (SHIMANO)

MODEL HIGHLIGHTS

- The Instinct is Rocky Mountain's most versatile platform
- Sleek, fully integrated design
- Intuitive & smooth DynamE 3.0 electric assist
- Super high torque drive output
- High capacity 672 Wh battery
- Fast charging: 500 Wh in 2 hrs, full in 3:25 from empty!

IMPROVEMENTS OVER PREVIOUS MODEL

- Improved production tolerances and methods for increased drive reliability
- All new Powerplay chain slider for noise reduction
- 672Wh battery
- Stiffer RockShox 35mm Revelation fork
- Shimano 4 piston brakes
- More robust tires

COLOUR 1



THE MAN IN BLACK
MATTE

THE MAN IN BLACK
GLOSS

FLAMING LIPS
MATTE/GLOSS

COLOUR 2



FOLSOM PRISON BLUE
GLOSS

THE MAN IN BLACK
GLOSS

NEVERMIND
GLOSS

Front Triangle	FORM Alloy. Full Sealed Cartridge Bearings. Press Fit BB. Internal Cable Routing. 2-Bolt ISCG05 Tabs. RIDE-9 Adjustable Geometry + Suspension Rate. 140mm Travel.
Chainstay	FORM Alloy
Seatstay	FORM Alloy
Drive System	DynamE 3.0 Drive 250w / 48v. iWoc TRIO Remote
Battery	Li-Ion 672 Watt/Hr
Fork	RockShox Revelation RC 140mm E-MTB Approved 42mm Offset
Rear Shock	RockShox Deluxe Select+ RT
F / Brake	Shimano MT520 4 Piston
R / Brake	Shimano MT520 4 Piston
F / Rotor	Shimano RT64 203mm
R / Rotor	Shimano RT64 203mm
R / Shifter	Shimano SLX
R / Derailleur	Shimano SLX
Crankset	Race Face Ride Cinch 34T
Bottom Bracket	Shimano SM-BBMT500
Cassette	Shimano SLX 10-51T
Chain	Shimano HG7100
F / Hub	Shimano MT400 Boost 15mm
R / Hub	Shimano M510 Boost 148mm
Spokes	DT Swiss Champion 2.0
F / Rim	WTB ST i35 TCS 2.0 Tubeless
R / Rim	WTB ST i35 TCS 2.0 Tubeless
F / Rim Tape	Tubeless Ready - Tape / Valves Incl.
R / Rim Tape	Tubeless Ready - Tape / Valves Incl.
F / Tire	Maxxis Minion DHF EXO Tubeless Ready 29 x 2.6
R / Tire	Maxxis Rekon EXO+ Silk Shield Tubeless Ready 29 x 2.6
Headset	FSA Orbit NO.57E
Stem	Rocky Mountain AM
Handlebar	Rocky Mountain AM 760mm
Grips / Tape	Rocky Mountain Lock On Light
Seatpost	Rocky Mountain Toonie Drop 30.9mm
Saddle	WTB Volt Race 142
Accessories	Offside Dual Waterbottle Adapter

B0072

MSRP

Instinct Powerplay Alloy 30

MODEL HIGHLIGHTS

- The Instinct is Rocky Mountain's most versatile platform
- Sleek, fully integrated design
- Intuitive & smooth Dynamac 3.0 electric assist
- Super high torque drive output
- High capacity 672 Wh battery
- Fast charging: 500 Wh in 2 hrs, full in 3:25 from empty!

COLOUR 1



THE MAN IN BLACK
MATTE

THE MAN IN BLACK
GLOSS

FLAMING LIPS
MATTE/GLOSS

Front Triangle	FORM Alloy. Full Sealed Cartridge Bearings. Press Fit BB. Internal Cable Routing. 2-Bolt ISCG05 Tabs. RIDE-9 Adjustable Geometry + Suspension Rate. 140mm Travel.
Chainstay	FORM Alloy
Seatstay	FORM Alloy
Drive System	Dynamac 3.0 Drive 250w / 48v. iWoc TRIO Remote
Battery	Li-Ion 672 Watt/Hr
Fork	RockShox 35 Gold RL 140mm E-MTB Approved 44mm Offset
Rear Shock	RockShox Deluxe Select+ RT
F / Brake	Shimano MT420 4 Piston
R / Brake	Shimano MT400
F / Rotor	Shimano RT64 203mm
R / Rotor	Shimano RT64 203mm
R / Shifter	Shimano Deore
R / Derailleur	Shimano Deore
Crankset	Race Face Ride Cinch 34T
Bottom Bracket	Shimano SM-BBMT500
Cassette	SunRace CSMS2 11-46T
Chain	KMC X10-1
F / Hub	Shimano MT400 Boost 15mm
R / Hub	Shimano MT400 Boost 148mm
Spokes	2.0 Stainless
F / Rim	WTB ST i35 TCS 2.0 Tubeless
R / Rim	WTB ST i35 TCS 2.0 Tubeless
F / Rim Tape	Tubeless Ready - Tape / Valves Incl.
R / Rim Tape	Tubeless Ready - Tape / Valves Incl.
F / Tire	Maxxis Minion DHF EXO Tubeless Ready 29 x 2.6
R / Tire	Maxxis Rekon EXO+ Silk Shield Tubeless Ready 29 x 2.6
Headset	FSA Orbit NO.57E
Stem	Rocky Mountain AM
Handlebar	Rocky Mountain AM 760mm
Grips / Tape	Rocky Mountain Lock On Light
Seatpost	Rocky Mountain Toonie Drop 30.9mm
Saddle	WTB Volt Race 142
Accessories	Offside Dual Waterbottle Adapter



INSTINCT POWERPLAY ALLOY BC EDITION

DESIGNED FOR
Aggressive Trail

WHEEL SIZE
29" (27.5+ ready)

FRONT TRAVEL
160 MM

REAR TRAVEL
155 MM

Our Instinct BC edition has proven itself as one of the most capable bikes in our lineup. Now imagine what it can do with the assistance of our Dynamx 3.0 drive system.

Smash down chutes, rail through corners, and then turn it up to "ludicrous" to climb back to the top faster than you ever thought possible. Designed with an optimized single-position link and a long stroke shock that provides 155mm of rear travel, integrated Dynamx 3.0 drive system, and a component spec meant for charging hard, our BC Edition build has everything you want and more.

GEOMETRY

- HTA** Head Tube Angle (deg)
- STA** Seat Tube Angle (deg)
- STL** Seat Tube Length (mm)
- TTH** Top Tube Horizontal (mm)
- HTL** Head Tube Length (mm)
- RC** Rear Centre (mm)
- BBD** Bottom Bracket Drop (mm)
- SH** Standover Height (mm)
- WB** Wheelbase (mm)
- R** Reach (mm)
- S** Stack (mm)

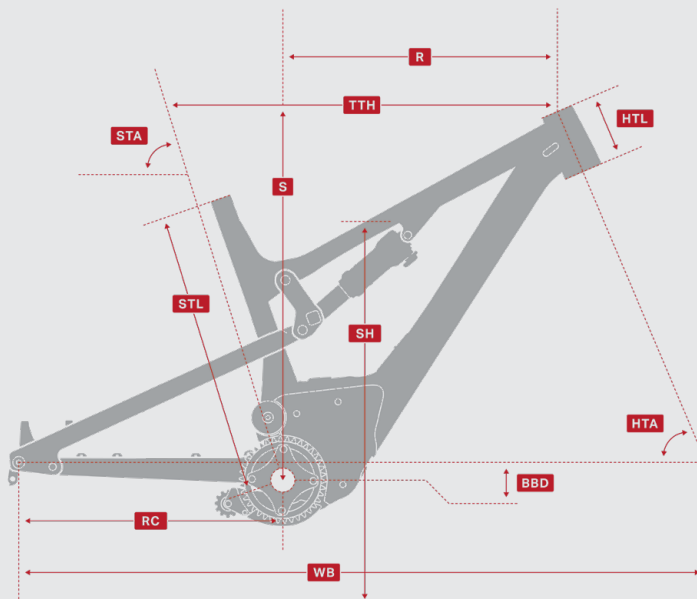

	SM	MD	LG	XL
HTA	65.9°	65.9°	65.9°	65.9°
STA	74.6°	74.6°	74.5°	74.5°
STL	394	432	470	508
TTH	573	597	624	654
HTL	100	100	110	120
RC	442	442	442	442
BBD	19	19	19	19
SH	834	829	828	827
WB	1168	1194	1220	1252
R	407	431	454	481
S	607	612	621	630

INSTINCT POWERPLAY COLOURWAYS

Alloy 70 BC Edition / 50 BC Edition

COLOUR 1

Instinct Powerplay Alloy 70 BC Edition shown



THE MAN IN BLACK
GLOSS

POISON
GLOSS

BRASS MONKEY
GLOSS

Rider:
Andreas Hestler

Photo:
Margus Riga

Location:
North Vancouver, BC



B0082

MSRP

Instinct Powerplay Alloy 70 BC EDITION

MODEL HIGHLIGHTS

- Powerplay assist meets trail smashing Instinct BC Edition
- Sleek, fully integrated design
- Intuitive & smooth DynamE 3.0 electric assist
- Super high torque drive output
- High capacity 672 Wh battery
- Fast charging: 500 Wh in 2 hrs, full in 3:25 from empty!

COLOUR 1



THE MAN IN BLACK
GLOSS

POISON
GLOSS

BRASS MONKEY
GLOSS

Front Triangle	FORM Alloy. Full Sealed Cartridge Bearings. Press Fit BB. Internal Cable Routing. 2-Bolt ISCG05 Tabs. 160mm Travel.
Chainstay	FORM Alloy
Seatstay	FORM Alloy
Drive System	DynamE 3.0 Drive 250w / 48v. iWoc TRIO Remote
Battery	Li-Ion 672 Watt/Hr
Fork	Fox 36 E-MTB Float EVOL Grip Performance 160mm 44mm Offset
Rear Shock	Fox Float DPX2 Performance
F / Brake	Shimano XT Trail 4 Piston
R / Brake	Shimano XT Trail 4 Piston
F / Rotor	Shimano RT66 203mm
R / Rotor	Shimano RT66 203mm
R / Shifter	Shimano XT
R / Derailleur	Shimano XT
Crankset	Race Face Aeffect Cinch 34T
Bottom Bracket	Shimano SM-BBMT500
Cassette	Shimano XT 10-51T
Chain	Shimano HG8100
F / Hub	Rocky Mountain Sealed Boost 15mm
R / Hub	DT Swiss Hybrid 370 Boost 148mm
Spokes	DT Swiss Alpine 2.3/2.0
F / Rim	Race Face AR 30
R / Rim	Race Face AR 30
F / Rim Tape	Tubeless Ready - Tape / Valves Incl.
R / Rim Tape	Tubeless Ready - Tape / Valves Incl.
F / Tire	Maxxis Minion DHF WT Double Down Maxx Grip 3C Tubeless Ready 29 x 2.5
R / Tire	Maxxis Aggressor WT Double Down Tubeless Ready 29 x 2.5
Headset	FSA Orbit NO.57E
Stem	Rocky Mountain 35 AM
Handlebar	Rocky Mountain AM 780mm
Grips / Tape	Rocky Mountain Lock On Light
Seatpost	Race Face Turbine R (by Fox) Dropper 30.9mm
Saddle	WTB Volt Race 142
Accessories	Offside Dual Waterbottle Adapter

B0083

MSRP

Instinct Powerplay Alloy 50 BC EDITION

MODEL HIGHLIGHTS

- Powerplay assist meets trail smashing Instinct BC Edition
- Sleek, fully integrated design
- Intuitive & smooth DynamE 3.0 electric assist
- Super high torque drive output
- High capacity 672 Wh battery
- Fast charging: 500 Wh in 2 hrs, full in 3:25 from empty!

COLOUR 1



THE MAN IN BLACK
GLOSS

POISON
GLOSS

BRASS MONKEY
GLOSS

Front Triangle	FORM Alloy. Full Sealed Cartridge Bearings. Press Fit BB. Internal Cable Routing. 2-Bolt ISCG05 Tabs. 160mm Travel.
Chainstay	FORM Alloy
Seatstay	FORM Alloy
Drive System	DynamE 3.0 Drive 250w / 48v. iWoc TRIO Remote
Battery	Li-Ion 672 Watt/Hr
Fork	RockShox Yari RC 160mm 42mm Offset
Rear Shock	Fox Float DPX2 Performance
F / Brake	Shimano MT520 4 Piston
R / Brake	Shimano MT520 4 Piston
F / Rotor	Shimano RT64 203mm
R / Rotor	Shimano RT64 203mm
R / Shifter	Shimano SLX
R / Derailleur	Shimano SLX
Crankset	Race Face Ride Cinch 34T
Bottom Bracket	Shimano SM-BBMT500
Cassette	Shimano SLX 10-51T
Chain	Shimano HG7100
F / Hub	Shimano MT400 Boost 15mm
R / Hub	Shimano M510 Boost 148mm
Spokes	DT Swiss Champion 2.0
F / Rim	WTB ST i30 TCS 2.0 Tubeless
R / Rim	WTB ST i30 TCS 2.0 Tubeless
F / Rim Tape	Tubeless Ready - Tape / Valves Incl.
R / Rim Tape	Tubeless Ready - Tape / Valves Incl.
F / Tire	Maxxis Minion DHF WT Double Down Maxx Grip 3C Tubeless Ready 29 x 2.5
R / Tire	Maxxis Aggressor WT Double Down Tubeless Ready 29 x 2.5
Headset	FSA Orbit NO.57E
Stem	Rocky Mountain 35 AM
Handlebar	Rocky Mountain AM 780mm
Grips / Tape	Rocky Mountain Lock On Light
Seatpost	Rocky Mountain Toonie Drop 30.9mm
Saddle	WTB Volt Race 142
Accessories	Offside Dual Waterbottle Adapter

ALTITUDE POWER PLAY

DESIGNED FOR
Aggressive Trail

FRONT TRAVEL
160 MM

REAR TRAVEL
150 MM







WHEEL SIZE
27.5 Wide Trail

NOTES

Ride more, further, faster. The Altitude Powerplay brings cutting-edge power to an aggressive trail bike and opens the door to amazing terrain for all.

This is our fully integrated, electric-assist mountain bike that takes our Altitude’s legendary handling and ride quality and adds a compact, powerful drive system. The Dyname 3.0 drive system was designed in parallel with the frame, delivering ultra-short chainstays, optimized suspension kinematics, super-low centre of gravity, and class-leading torque. The result is an eMTB that actually rides like a proper mountain bike—perfect for everything from self-shuttling all mountain trails, finding flow between the descents, and squeezing in power lunch rides.

FRAME TECHNOLOGY

-  **Dyname 3.0**
DRIVE SYSTEM
-  **Smoothwall Carbon**
FRAME MATERIAL
-  **FORM Alloy**
FRAME MATERIAL
-  **RIDE-9**
ADJUSTMENT SYSTEM
-  **Smoothlink**
SUSPENSION
-  **Size Specific**
TUNE

Rider:
Wade Simmons

Photo:
Ale di Lullo

Location :
Italy



ALTITUDE POWERPLAY CARBON & ALLOY

GEOMETRY

Geometry shown for Slack, Neutral, and Steep RIDE-9™ positions.

- HTA** Head Tube Angle (deg)
- STA** Seat Tube Angle (deg)
- STL** Seat Tube Length (mm)
- TTH** Top Tube Horizontal (mm)
- HTL** Head Tube Length (mm)
- RC** Rear Centre (mm)
- BBD** Bottom Bracket Drop (mm)
- SH** Standover Height (mm)
- WB** Wheelbase (mm)
- R** Reach (mm)
- S** Stack (mm)

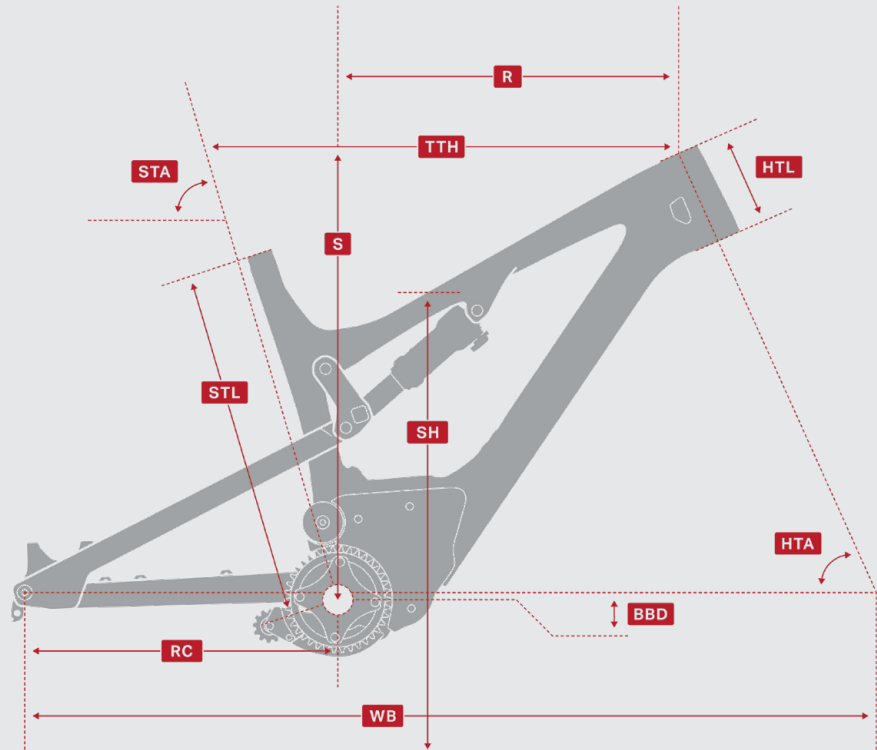

	SM			MD			LG			XL		
	Slack	Neutral	Steep	Slack	Neutral	Steep	Slack	Neutral	Steep	Slack	Neutral	Steep
HTA	64.5°	65°	65.6°	65°	65.6°	66.1°	65°	65.6°	66.1°	65.1°	65.6°	66.1°
STA	74°	74.5°	75.1°	74°	74.6°	75.1°	74°	74.6°	75.1°	74.1°	74.6°	75.1°
STL	419	419	419	457	457	457	483	483	483	521	521	521
TTH	578	576	575	603	601	600	628	626	625	658	656	655
HTL	100	100	100	120	120	120	130	130	130	145	145	145
RC	426	425	423	426	425	423	426	425	423	426	425	423
BBD	14	7	1	14	7	1	14	7	1	14	7	1
SH	810	813	816	816	818	821	814	816	819	813	816	819
WB	1157	1156	1155	1180	1179	1177	1206	1205	1204	1239	1238	1236
R	411	416	422	430	435	441	452	458	464	479	484	490
S	583	579	575	604	600	596	614	610	605	628	623	619

ALTITUDE POWERPLAY COLOURWAYS

Carbon 90 Rally Edition / 70 / 50

COLOUR 1

Altitude Powerplay Carbon 90 Rally Edition shown



BACK IN BLACK
GLOSS

BILLY OCEAN
GLOSS

FOX RACING ORANGE
GLOSS

Carbon 90 Rally Edition / 70 / 50

COLOUR 2

Altitude Powerplay Carbon 90 Rally Edition shown



ZOMBIE
GLOSS

SPACE ODDITY
GLOSS

BRASS MONKEY
GLOSS

B0073

MSRP

Altitude Powerplay Carbon 90 RALLY ED.

MODEL HIGHLIGHTS

- Electric Enduro race ready, out of the box
- Sleek, fully integrated design
- Intuitive & smooth DynamE 3.0 electric assist
- Super high torque drive output
- High capacity 672 Wh battery
- Fast charging: 500 Wh in 2 hrs, full in 3:25 from empty!

IMPROVEMENTS OVER PREVIOUS MODEL

- Short offset fork for high speed stability
- Double Down tire casing for puncture protection

COLOUR 1



BACK IN BLACK
GLOSS

BILLY OCEAN
GLOSS

FOX RACING ORANGE
GLOSS

COLOUR 2



ZOMBIE
GLOSS

SPACE ODDITY
GLOSS

BRASS MONKEY
GLOSS

Front Triangle	Smoothwall Carbon. Full Sealed Cartridge Bearings. Press Fit BB. Internal Cable Routing. 2-Bolt ISCG05 Tabs. RIDE-9 Adjustable Geometry + Suspension Rate. 150mm Travel.
Chainstay	Smoothwall Carbon
Seatstay	Smoothwall Carbon
Drive System	DynamE 3.0 Drive 250w / 48v. iWoc TRIO Remote
Battery	Li-Ion 672 Watt/Hr
Fork	Fox 36 E-MTB Float EVOL GRIP2 Factory 160mm 37mm Offset
Rear Shock	Fox Float X2 Factory
F / Brake	Shimano XT Trail 4 Piston
R / Brake	Shimano XT Trail 4 Piston
F / Rotor	Shimano RT86 203mm
R / Rotor	Shimano RT86 203mm
R / Shifter	Shimano XT
R / Derailleur	Shimano XT
Crankset	Race Face Turbine Cinch 34T
Bottom Bracket	Race Face BB92 30mm
Cassette	Shimano XT 10-51T
Chain	Shimano HG8100
F / Hub	Rocky Mountain Sealed Boost 15mm
R / Hub	DT Swiss Hybrid 350 Boost 148mm
Spokes	DT Swiss Alpine 2.3/2.0
F / Rim	Race Face ARC 35
R / Rim	Race Face ARC 35
F / Rim Tape	Tubeless Ready - Tape / Valves Incl.
R / Rim Tape	Tubeless Ready - Tape / Valves Incl.
F / Tire	Maxxis Minion DHF WT Double Down Maxx Grip 3C Tubeless Ready 27.5 x 2.5
R / Tire	Maxxis Aggressor WT Double Down Tubeless Ready 27.5 x 2.5
Headset	FSA Orbit NO.57E
Stem	Rocky Mountain 35 CNC
Handlebar	Race Face Turbine R 780mm
Grips / Tape	Rocky Mountain Lock On XC
Seatpost	Race Face Turbine R (by Fox) Dropper 30.9mm
Saddle	WTB Volt Race 142

B0074

MSRP

Altitude Powerplay Carbon 70 (SRAM)

MODEL HIGHLIGHTS

- Altitude fun, assisted
- Sleek, fully integrated design
- Intuitive & smooth Dyname 3.0 electric assist
- Super high torque drive output
- High capacity 672 Wh battery
- Fast charging: 500 Wh in 2 hrs, full in 3:25 from empty!

IMPROVEMENTS OVER PREVIOUS MODEL

- Short offset fork for high speed stability
- Double Down tire casing for puncture protection
- Sram E single click shifter

COLOUR 1



BACK IN BLACK
GLOSS

BILLY OCEAN
GLOSS

FOX RACING ORANGE
GLOSS

COLOUR 2



ZOMBIE
GLOSS

SPACE ODDITY
GLOSS

BRASS MONKEY
GLOSS

Front Triangle	Smoothwall Carbon. Full Sealed Cartridge Bearings. Press Fit BB. Internal Cable Routing. 2-Bolt ISCG05 Tabs. RIDE-9 Adjustable Geometry + Suspension Rate. 150mm Travel.
Chainstay	FORM Alloy
Seatstay	FORM Alloy
Drive System	Dyname 3.0 Drive 250w / 48v. iWoc TRIO Remote
Battery	Li-Ion 672 Watt/Hr
Fork	Fox 36 Float EVOL FIT4 Performance Elite 160mm 37mm Offset
Rear Shock	Fox Float DPS EVOL Performance Elite
F / Brake	Shimano XT Trail 4 Piston
R / Brake	Shimano XT Trail 4 Piston
F / Rotor	Shimano RT66 203mm
R / Rotor	Shimano RT66 203mm
R / Shifter	Sram GX-1E Eagle
R / Derailleur	Sram GX Eagle
Crankset	Race Face Aeffect Cinch 34T
Bottom Bracket	Shimano SM-BB71
Cassette	Sram PG-1230 11-50T
Chain	Sram NX Eagle. E-MTB Approved.
F / Hub	Rocky Mountain Sealed Boost 15mm
R / Hub	DT Swiss Hybrid 370 Boost 148mm
Spokes	DT Swiss Alpine 2.3/2.0
F / Rim	Race Face AR 35
R / Rim	Race Face AR 35
F / Rim Tape	Tubeless Ready - Tape / Valves Incl.
R / Rim Tape	Tubeless Ready - Tape / Valves Incl.
F / Tire	Maxxis Minion DHF WT Double Down Maxx Grip 3C Tubeless Ready 27.5 x 2.5
R / Tire	Maxxis Aggressor WT Double Down Tubeless Ready 27.5 x 2.5
Headset	FSA Orbit NO.57E
Stem	Rocky Mountain 35 AM
Handlebar	Rocky Mountain AM 780mm
Grips / Tape	Rocky Mountain Lock On Light
Seatpost	Race Face Turbine R (by Fox) Dropper 30.9mm
Saddle	WTB Volt Race 142

B0089

MSRP

Altitude Powerplay Carbon 70 (SHIMANO)

MODEL HIGHLIGHTS

- Altitude fun, assisted
- Sleek, fully integrated design
- Intuitive & smooth Dyname 3.0 electric assist
- Super high torque drive output
- High capacity 672 Wh battery
- Fast charging: 500 Wh in 2 hrs, full in 3:25 from empty!

IMPROVEMENTS OVER PREVIOUS MODEL

- Short offset fork for high speed stability
- Double Down tire casing for puncture protection
- New Shimano 12spd groupo

COLOUR 1



BACK IN BLACK
GLOSS

BILLY OCEAN
GLOSS

FOX RACING ORANGE
GLOSS

COLOUR 2



ZOMBIE
GLOSS

SPACE ODDITY
GLOSS

BRASS MONKEY
GLOSS

Image for colour and graphic reference only. Please refer to specification table.

Front Triangle

Smoothwall Carbon. Full Sealed Cartridge Bearings. Press Fit BB. Internal Cable Routing. 2-Bolt ISCG05 Tabs. RIDE-9 Adjustable Geometry + Suspension Rate. 150mm Travel.

Chainstay

FORM Alloy

Seatstay

FORM Alloy

Drive System

Dyname 3.0 Drive 250w / 48v. iWoc TRIO Remote

Battery

Li-Ion 672 Watt/Hr

Fork

RockShox Lyrik Select+ RC 160mm 37mm Offset

Rear Shock

RockShox Deluxe Select+ RT

F / Brake

Shimano XT Trail 4 Piston

R / Brake

Shimano XT Trail 4 Piston

F / Rotor

Shimano RT66 203mm

R / Rotor

Shimano RT66 203mm

R / Shifter

Shimano XT

R / Derailleur

Shimano XT

Crankset

Race Face Aeffect Cinch 34T

Bottom Bracket

Shimano SM-BB71

Cassette

Shimano XT 10-51T

Chain

Shimano HG8100

F / Hub

Rocky Mountain Sealed Boost 15mm

R / Hub

DT Swiss Hybrid 370 Boost 148mm

Spokes

DT Swiss Alpine 2.3/2.0

F / Rim

Race Face AR 35

R / Rim

Race Face AR 35

F / Rim Tape

Tubeless Ready - Tape / Valves Incl.

R / Rim Tape

Tubeless Ready - Tape / Valves Incl.

F / Tire

Maxxis Minion DHF WT Double Down Maxx Grip 3C Tubeless Ready 27.5 x 2.5

R / Tire

Maxxis Aggressor WT Double Down Tubeless Ready 27.5 x 2.5

Headset

FSA Orbit NO.57E

Stem

Rocky Mountain 35 AM

Handlebar

Rocky Mountain AM 780mm

Grips / Tape

Rocky Mountain Lock On Light

Seatpost

Race Face Turbine R (by Fox) Dropper 30.9mm

Saddle

WTB Volt Race 142

Specifications are subject to change without notice.

B0075

MSRP

Altitude Powerplay Carbon 50 (SRAM)

MODEL HIGHLIGHTS

- Altitude fun, assisted
- Sleek, fully integrated design
- Intuitive & smooth Dynamine 3.0 electric assist
- Super high torque drive output
- High capacity 672 Wh battery
- Fast charging: 500 Wh in 2 hrs, full in 3:25 from empty!

IMPROVEMENTS OVER PREVIOUS MODEL

- Short offset fork for high speed stability
- Double Down tire casing for puncture protection
- Sram E single click shifter

COLOUR 1



BACK IN BLACK
GLOSS

BILLY OCEAN
GLOSS

FOX RACING ORANGE
GLOSS

COLOUR 2



ZOMBIE
GLOSS

SPACE ODDITY
GLOSS

BRASS MONKEY
GLOSS

Front Triangle

Smoothwall Carbon. Full Sealed Cartridge Bearings. Press Fit BB. Internal Cable Routing. 2-Bolt ISCG05 Tabs. RIDE-9 Adjustable Geometry + Suspension Rate. 150mm Travel.

Chainstay

FORM Alloy

Seatstay

FORM Alloy

Drive System

Dynamine 3.0 Drive 250w / 48v. iWoc TRIO Remote

Battery

Li-Ion 672 Watt/Hr

Fork

RockShox Lyrik Select RC 160mm 37mm Offset

Rear Shock

RockShox Deluxe Select+ RT

F / Brake

Shimano MT520 4 Piston

R / Brake

Shimano MT520 4 Piston

F / Rotor

Shimano RT66 203mm

R / Rotor

Shimano RT66 203mm

R / Shifter

Sram NX-1E Eagle

R / Derailleur

Sram GX Eagle

Crankset

Race Face Ride Cinch 34T

Bottom Bracket

Shimano SM-BBMT500

Cassette

Sram PG-1230 11-50T

Chain

Sram NX Eagle. E-MTB Approved.

F / Hub

Rocky Mountain Sealed Boost 15mm Torque Cap

R / Hub

DT Swiss Hybrid 370 Boost 148mm

Spokes

DT Swiss Alpine 2.3/2.0

F / Rim

WTB ST i35 TCS 2.0 Tubeless

R / Rim

WTB ST i35 TCS 2.0 Tubeless

F / Rim Tape

Tubeless Ready - Tape / Valves Incl.

R / Rim Tape

Tubeless Ready - Tape / Valves Incl.

F / Tire

Maxxis Minion DHF WT Double Down Maxx Grip 3C Tubeless Ready 27.5 x 2.5

R / Tire

Maxxis Aggressor WT Double Down Tubeless Ready 27.5 x 2.5

Headset

FSA Orbit NO.57E

Stem

Rocky Mountain 35 AM

Handlebar

Rocky Mountain AM 780mm

Grips / Tape

Rocky Mountain Lock On Light

Seatpost

Race Face Aeffect R Dropper 30.9mm

Saddle

WTB Volt Race 142

B0090

MSRP

Altitude Powerplay Carbon 50 (SHIMANO)

MODEL HIGHLIGHTS

- Altitude fun, assisted
- Sleek, fully integrated design
- Intuitive & smooth Dyname 3.0 electric assist
- Super high torque drive output
- High capacity 672 Wh battery
- Fast charging: 500 Wh in 2 hrs, full in 3:25 from empty!

IMPROVEMENTS OVER PREVIOUS MODEL

- 632 Wh battery
- Short offset fork for high speed stability
- Double Down tire casing for puncture protection
- New Shimano 12spd groupo

COLOUR 1



BACK IN BLACK
GLOSS

BILLY OCEAN
GLOSS

FOX RACING ORANGE
GLOSS

COLOUR 2



ZOMBIE
GLOSS

SPACE ODDITY
GLOSS

BRASS MONKEY
GLOSS

Image for colour and graphic reference only. Please refer to specification table.

Front Triangle	Smoothwall Carbon. Full Sealed Cartridge Bearings. Press Fit BB. Internal Cable Routing. 2-Bolt ISCG05 Tabs. RIDE-9 Adjustable Geometry + Suspension Rate. 150mm Travel.
Chainstay	FORM Alloy
Seatstay	FORM Alloy
Drive System	Dyname 3.0 Drive 250w / 48v. iWoc TRIO Remote
Battery	Li-Ion 672 Watt/Hr
Fork	RockShox Yari RC 160mm 37mm Offset
Rear Shock	RockShox Deluxe Select+ RT
F / Brake	Shimano MT520 4 Piston
R / Brake	Shimano MT520 4 Piston
F / Rotor	Shimano RT66 203mm
R / Rotor	Shimano RT66 203mm
R / Shifter	Shimano SLX
R / Derailleur	Shimano SLX
Crankset	Race Face Ride Cinch 34T
Bottom Bracket	Shimano SM-BBMT500
Cassette	Shimano SLX 10-51T
Chain	Shimano HG7100
F / Hub	Rocky Mountain Sealed Boost 15mm Torque Cap
R / Hub	DT Swiss Hybrid 370 Boost 148mm
Spokes	DT Swiss Alpine 2.3/2.0
F / Rim	WTB ST i35 TCS 2.0 Tubeless
R / Rim	WTB ST i35 TCS 2.0 Tubeless
F / Rim Tape	Tubeless Ready - Tape / Valves Incl.
R / Rim Tape	Tubeless Ready - Tape / Valves Incl.
F / Tire	Maxxis Minion DHF WT Double Down Maxx Grip 3C Tubeless Ready 27.5 x 2.5
R / Tire	Maxxis Aggressor WT Double Down Tubeless Ready 27.5 x 2.5
Headset	FSA Orbit NO.57E
Stem	Rocky Mountain 35 AM
Handlebar	Rocky Mountain AM 780mm
Grips / Tape	Rocky Mountain Lock On Light
Seatpost	Rocky Mountain Toonie Drop 30.9mm
Saddle	WTB Volt Race 142

Specifications are subject to change without notice.

ALTITUDE POWERPLAY COLOURWAYS

Alloy 70 / 50

COLOUR 1

Altitude Powerplay Alloy 70 (Sram) shown



BACK IN BLACK
GLOSS

BILLY OCEAN
GLOSS

FOX RACING ORANGE
GLOSS

Alloy 70 / 50

COLOUR 2

Altitude Powerplay Alloy 70 (Sram) shown



ZOMBIE
GLOSS

SPACE ODDITY
GLOSS

BRASS MONKEY
GLOSS

B0076

MSRP

Altitude Powerplay Alloy 70 (SRAM)

MODEL HIGHLIGHTS

- Altitude fun, assisted
- Sleek, fully integrated design
- Intuitive & smooth Dynamore 3.0 electric assist
- Super high torque drive output
- High capacity 672 Wh battery
- Fast charging: 500 Wh in 2 hrs, full in 3:25 from empty!

IMPROVEMENTS OVER PREVIOUS MODEL

- Short offset fork for high speed stability
- Sram Code DH brakes
- Double Down tire casing for puncture protection

COLOUR 1



BACK IN BLACK
GLOSS

BILLY OCEAN
GLOSS

FOX RACING ORANGE
GLOSS

COLOUR 2



ZOMBIE
GLOSS

SPACE ODDITY
GLOSS

BRASS MONKEY
GLOSS

Front Triangle	FORM Alloy. Full Sealed Cartridge Bearings. Press Fit BB. Internal Cable Routing. 2-Bolt ISCG05 Tabs. RIDE-9 Adjustable Geometry + Suspension Rate. 150mm Travel.
Chainstay	FORM Alloy
Seatstay	FORM Alloy
Drive System	Dynamore 3.0 Drive 250w / 48v. iWoc TRIO Remote
Battery	Li-Ion 672 Watt/Hr
Fork	Fox 36 E-MTB Float EVOL Grip Performance 160mm 37mm Offset
Rear Shock	Fox Float DPS EVOL Performance
F / Brake	Sram Code R
R / Brake	Sram Code R
F / Rotor	Sram Centerline 200mm
R / Rotor	Sram Centerline 200mm
R / Shifter	Sram GX-1E Eagle
R / Derailleur	Sram GX Eagle
Crankset	Race Face Aeffect Cinch 34T
Bottom Bracket	Shimano SM-BBMT500
Cassette	Sram PG-1230 11-50T
Chain	Sram NX Eagle. E-MTB Approved.
F / Hub	Rocky Mountain Sealed Boost 15mm
R / Hub	DT Swiss Hybrid 370 Boost 148mm
Spokes	DT Swiss Alpine 2.3/2.0
F / Rim	WTB ST i35 TCS 2.0 Tubeless
R / Rim	WTB ST i35 TCS 2.0 Tubeless
F / Rim Tape	Tubeless Ready - Tape / Valves Incl.
R / Rim Tape	Tubeless Ready - Tape / Valves Incl.
F / Tire	Maxxis Minion DHF WT Double Down Maxx Grip 3C Tubeless Ready 27.5 x 2.5
R / Tire	Maxxis Aggressor WT Double Down Tubeless Ready 27.5 x 2.5
Headset	FSA Orbit NO.57E
Stem	Rocky Mountain 35 AM
Handlebar	Rocky Mountain AM 780mm
Grips / Tape	Rocky Mountain Lock On Light
Seatpost	Race Face Turbine R (by Fox) Dropper 30.9mm
Saddle	WTB Volt Race 142
Accessories	Offside Dual Waterbottle Adapter

B0091

MSRP

Altitude Powerplay Alloy 70 (SHIMANO)

MODEL HIGHLIGHTS

- Altitude fun, assisted
- Sleek, fully integrated design
- Intuitive & smooth Dyname 3.0 electric assist
- Super high torque drive output
- High capacity 672 Wh battery
- Fast charging: 500 Wh in 2 hrs, full in 3:25 from empty!

IMPROVEMENTS OVER PREVIOUS MODEL

- Short offset fork for high speed stability
- Shimano XT brakes & 12spd groupset
- Double Down tire casing for puncture protection

COLOUR 1



BACK IN BLACK
GLOSS

BILLY OCEAN
GLOSS

FOX RACING ORANGE
GLOSS

COLOUR 2



ZOMBIE
GLOSS

SPACE ODDITY
GLOSS

BRASS MONKEY
GLOSS

Front Triangle	FORM Alloy. Full Sealed Cartridge Bearings. Press Fit BB. Internal Cable Routing. 2-Bolt ISCG05 Tabs. RIDE-9 Adjustable Geometry + Suspension Rate. 150mm Travel.
Chainstay	FORM Alloy
Seatstay	FORM Alloy
Drive System	Dyname 3.0 Drive 250w / 48v. iWoc TRIO Remote
Battery	Li-Ion 672 Watt/Hr
Fork	RockShox Lyrik Select RC 160mm 37mm Offset
Rear Shock	RockShox Deluxe Select+ RT
F / Brake	Shimano XT
R / Brake	Shimano XT
F / Rotor	Shimano RT66 203mm
R / Rotor	Shimano RT66 203mm
R / Shifter	Shimano XT
R / Derailleur	Shimano XT
Crankset	Race Face Aeffect Cinch 34T
Bottom Bracket	Shimano SM-BBMT500
Cassette	Shimano XT 10-51T
Chain	Shimano HG8100
F / Hub	Rocky Mountain Sealed Boost 15mm
R / Hub	DT Swiss Hybrid 370 Boost 148mm
Spokes	DT Swiss Alpine 2.3/2.0
F / Rim	WTB ST i35 TCS 2.0 Tubeless
R / Rim	WTB ST i35 TCS 2.0 Tubeless
F / Rim Tape	Tubeless Ready - Tape / Valves Incl.
R / Rim Tape	Tubeless Ready - Tape / Valves Incl.
F / Tire	Maxxis Minion DHF WT Double Down Maxx Grip 3C Tubeless Ready 27.5 x 2.5
R / Tire	Maxxis Aggressor WT Double Down Tubeless Ready 27.5 x 2.5
Headset	FSA Orbit NO.57E
Stem	Rocky Mountain 35 AM
Handlebar	Rocky Mountain AM 780mm
Grips / Tape	Rocky Mountain Lock On Light
Seatpost	Race Face Turbine R (by Fox) Dropper 30.9mm
Saddle	WTB Volt Race 142
Accessories	Offside Dual Waterbottle Adapter

B0077

MSRP

Altitude Powerplay Alloy 50 (SRAM)

MODEL HIGHLIGHTS

- Altitude fun, assisted
- Sleek, fully integrated design
- Intuitive & smooth Dyname 3.0 electric assist
- Super high torque drive output
- High capacity 672 Wh battery
- Fast charging: 500 Wh in 2 hrs, full in 3:25 from empty!

IMPROVEMENTS OVER PREVIOUS MODEL

- Short offset fork for high speed stability
- Sram Guide RE (DH Caliper) brakes
- Double Down tire casing for puncture protection
- Sram Eagle 12spd drivetrain

COLOUR 1



BACK IN BLACK
GLOSS

BILLY OCEAN
GLOSS

FOX RACING ORANGE
GLOSS

COLOUR 2



ZOMBIE
GLOSS

SPACE ODDITY
GLOSS

BRASS MONKEY
GLOSS

Image for colour and graphic reference only. Please refer to specification table.

Front Triangle	FORM Alloy. Full Sealed Cartridge Bearings. Press Fit BB. Internal Cable Routing. 2-Bolt ISCG05 Tabs. RIDE-9 Adjustable Geometry + Suspension Rate. 150mm Travel.
Chainstay	FORM Alloy
Seatstay	FORM Alloy
Drive System	Dyname 3.0 Drive 250w / 48v. iWoc TRIO Remote
Battery	Li-Ion 672 Watt/Hr
Fork	RockShox Yari RC 160mm 37mm Offset
Rear Shock	RockShox Deluxe Select+ RT
F / Brake	Sram Guide RE
R / Brake	Sram Guide RE
F / Rotor	Sram Centerline 200mm
R / Rotor	Sram Centerline 200mm
R / Shifter	Sram NX-1E Eagle
R / Derailleur	Sram NX Eagle
Crankset	Race Face Ride Cinch 34T
Bottom Bracket	Shimano SM-BBMT500
Cassette	Sram PG-1230 11-50T
Chain	Sram SX Eagle. E-MTB Approved.
F / Hub	Shimano MT400 Boost 15mm
R / Hub	Shimano MT400 Boost 148mm
Spokes	DT Swiss Champion 2.0
F / Rim	WTB ST i35 TCS 2.0 Tubeless
R / Rim	WTB ST i35 TCS 2.0 Tubeless
F / Rim Tape	Tubeless Ready - Tape / Valves Incl.
R / Rim Tape	Tubeless Ready - Tape / Valves Incl.
F / Tire	Maxxis Minion DHF WT Double Down Maxx Grip 3C Tubeless Ready 27.5 x 2.5
R / Tire	Maxxis Aggressor WT Double Down Tubeless Ready 27.5 x 2.5
Headset	FSA Orbit NO.57E
Stem	Rocky Mountain 35 AM
Handlebar	Rocky Mountain AM 780mm
Grips / Tape	Rocky Mountain Lock On Light
Seatpost	Race Face Aeffect R Dropper 30.9mm
Saddle	WTB Volt Race 142
Accessories	Offside Dual Waterbottle Adapter

Specifications are subject to change without notice.

B0092

MSRP

Altitude Powerplay Alloy 50 (SHIMANO)

MODEL HIGHLIGHTS

- Altitude fun, assisted
- Sleek, fully integrated design
- Intuitive & smooth Dynamene 3.0 electric assist
- Super high torque drive output
- High capacity 672 Wh battery
- Fast charging: 500 Wh in 2 hrs, full in 3:25 from empty!

IMPROVEMENTS OVER PREVIOUS MODEL

- 632 Wh battery
- Short offset fork for high speed stability
- Shimano 4 piston brakes & 12spd groupo
- Double Down tire casing for puncture protection

COLOUR 1



BACK IN BLACK
GLOSS

BILLY OCEAN
GLOSS

FOX RACING ORANGE
GLOSS

COLOUR 2



ZOMBIE
GLOSS

SPACE ODDITY
GLOSS

BRASS MONKEY
GLOSS

Front Triangle	FORM Alloy. Full Sealed Cartridge Bearings. Press Fit BB. Internal Cable Routing. 2-Bolt ISCG05 Tabs. RIDE-9 Adjustable Geometry + Suspension Rate. 150mm Travel.
Chainstay	FORM Alloy
Seatstay	FORM Alloy
Drive System	Dynamene 3.0 Drive 250w / 48v. iWoc TRIO Remote
Battery	Li-Ion 672 Watt/Hr
Fork	RockShox Yari RC 160mm 37mm Offset
Rear Shock	RockShox Deluxe Select+ RT
F / Brake	Shimano MT520 4 Piston
R / Brake	Shimano MT520 4 Piston
F / Rotor	Shimano RT66 203mm
R / Rotor	Shimano RT66 203mm
R / Shifter	Shimano SLX
R / Derailleur	Shimano SLX
Crankset	Race Face Ride Cinch 34T
Bottom Bracket	Shimano SM-BBMT500
Cassette	Shimano SLX 10-51T
Chain	Shimano HG7100
F / Hub	Shimano MT400 Boost 15mm
R / Hub	Shimano M510 Boost 148mm
Spokes	DT Swiss Champion 2.0
F / Rim	WTB ST i35 TCS 2.0 Tubeless
R / Rim	WTB ST i35 TCS 2.0 Tubeless
F / Rim Tape	Tubeless Ready - Tape / Valves Incl.
R / Rim Tape	Tubeless Ready - Tape / Valves Incl.
F / Tire	Maxxis Minion DHF WT Double Down Maxx Grip 3C Tubeless Ready 27.5 x 2.5
R / Tire	Maxxis Aggressor WT Double Down Tubeless Ready 27.5 x 2.5
Headset	FSA Orbit NO.57E
Stem	Rocky Mountain 35 AM
Handlebar	Rocky Mountain AM 780mm
Grips / Tape	Rocky Mountain Lock On Light
Seatpost	Rocky Mountain Toonie Drop 30.9mm
Saddle	WTB Volt Race 142
Accessories	Offside Dual Waterbottle Adapter

Riders:

Thomas Vanderham
& Rémi Gauvin

Photo:

Mattias Fredriksson

Location:

Norway

ROCKY MOUNTAIN®

DYNAME™

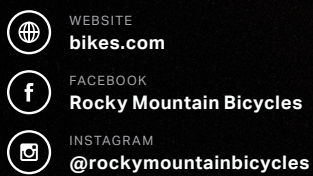

Rocky Mountain, its logo and other trade names are used by Rocky Mountain.
Some technologies on Rocky Mountain products are patented or patent pending.

Dyname, its logo and other trade names are used by Dyname.
Some technologies on Dyname products are patented or patent pending.

©2019 Rocky Mountain



Rider:
Thomas Vanderham

Photo:
Mattias Fredriksson

Location:
Norway



LOVE THE RIDE